



MEET YOUR

Petcube Bites 2

1 **PETCUBE BITES SPECS AND SYSTEM REQUIREMENTS**

Petcube Bites 2 features:

- 160° wide angle view
- 1080p HD video
- Treat dispenser
- 2-way audio
- Alexa Built-in
- Night vision
- 4x digital zoom
- Sound and motion alerts

Petcube Bites 2 requires:

- Wi-Fi 802.11b/g/n, 2.4-5GHz, password protected
- Bluetooth Low Energy (BLE)
- iOS 14 + and higher or Android 7.1.2 and higher
- Min 2 Mbps Upload speed on the Petcube (recommended 4 Mbps)
- Min 2 Mbps Download speed on the mobile device (recommended 4 Mbps)

2 SAFETY AND HANDLING

To avoid injuries or causing harm, read all safety information and operating instructions prior to using Petcube.

- Don't drop, hit, shake, or tumble your Petcube camera
- Don't stain, scratch, or otherwise damage the front panel
- Treats dispensed by Petcube Bites should not replace your pet's normal meals
- Petcube Bites should not be used to dispense medication to your pet
- Keep in mind treat expiration dates and ensure you are only providing your pets with fresh treats
- To prevent mechanical problems, use only compatible treats
- Be aware that using treats with your pet exposes them to choking hazards. Ensure your pet is familiar with the treats you are using and, that you monitor the consumption. You are not required to use any specific treats with Petcube Bites.
- Petcube should not be used by minors without supervision from an adult
- Don't expose to liquid, moisture, dust, excessive heat, or naked flame
- To avoid overheating, don't leave Petcube in direct sunlight
- Protect the power cord from being walked on, pinched or chewed on by pets

3 HOW TO ACCLIMATE YOUR PET TO PETCUBE BITES 2

Some pets may need an adjustment period to get used to Petcube Bites 2. Follow these simple steps to successfully introduce Bites 2 to your pet:

- Take time to positively introduce Bites 2 to your pet. Let them smell and inspect the device before you start operating it.
- Introduce them to the idea that treats will come out and give your pet a positive association with the device. Toss treats to your pet as though they're coming from the device. Put a treat into the dispensing hole and let them smell and see it.
- Disable the sound in settings to avoid your pet being alarmed by the speaker
- Stay in the room with your pet the first time you launch treats to provide encouragement and comfort
- Make sure your pet is not directly in front of the launcher. It is recommended to setup the device on a counter/shelf or wall mount it.

4 GETTING STARTED

1. Setting up your Petcube camera on iOS device

Step 1. To set up your Petcube, download Petcube application (fig 4.1.1) to your iOS device. The Petcube app requires iOS 14 or greater and can be downloaded in the App Store or at the link below:

www.petcu.be/ios-app-download

Step 2. Connect your Petcube to a power source and wait up to a minute until the LED light starts blinking green (fig 4.1.2).

Step 3. Open the Petcube app on your iOS device, and log in or sign up for a Petcube account (fig 4.1.3).

Step 4. Tap the 'Plus' icon in the right upper corner of the screen, and pick your Petcube from the list of options (fig 4.1.4). Make sure to turn on the Bluetooth before you continue.

Step 5. When the LED light on the camera is blinking green, hit 'Next' (fig 4.1.6).

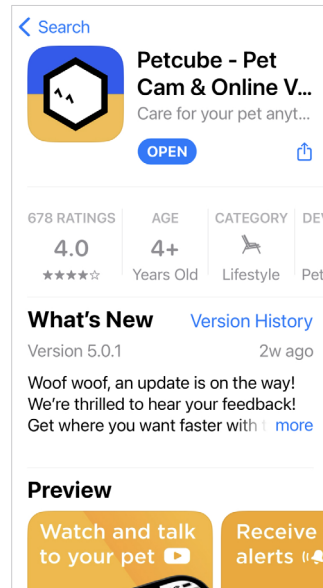

Fig. 4.1.1



Fig. 4.1.2

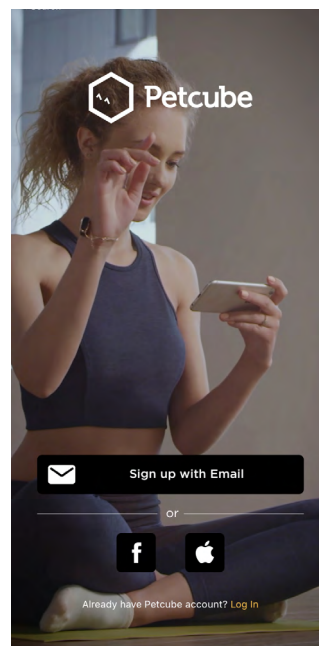

Fig. 4.1.3

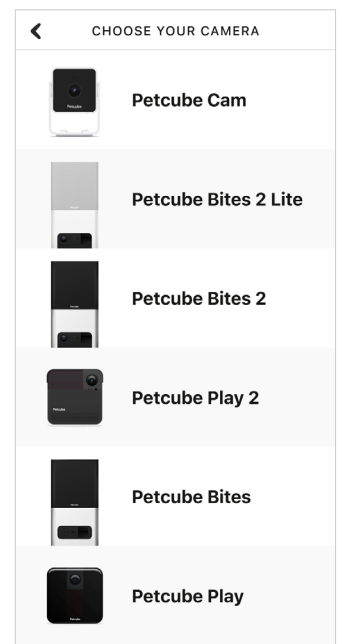

Fig. 4.1.4

Step 6. To identify your device, tap 'Select'. When the light on the device blinks green rapidly, tap 'Connect' (fig 4.1.7).

Step 7. Wait for the app to exchange data with the Petcube and scan for available Wi-Fi networks (fig 4.1.8), then select your home Wi-Fi network from the list (fig 4.1.9), put in your network password and hit 'Connect' (fig 4.1.10). If you don't see your home network on the list or if you're using a hidden network, connect to your home Wi-Fi by entering the name of your network and password manually and then hit 'Connect' (keep in mind that it is case sensitive).

Step 8. Your Petcube device is almost set up! Please wait until it connects and the light on the front turns white (fig 4.1.11).

Step 9. Once the LED light on your Petcube changes to solid white, you are ready to play with your Petcube (fig 4.1.12).

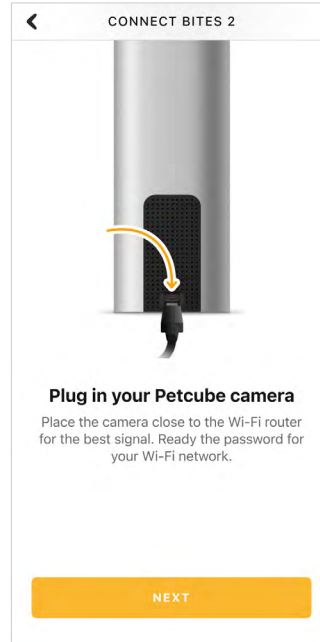

Fig. 4.1.5

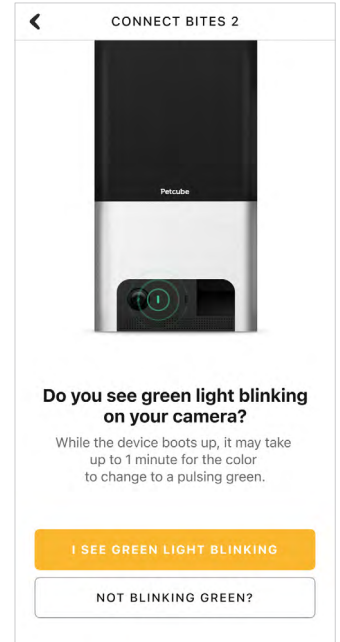

Fig. 4.1.6

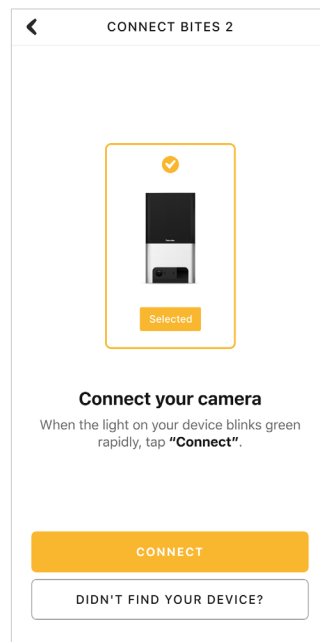

Fig. 4.1.7



Fig. 4.1.8

Reminder: It is likely that your Petcube will need a firmware update right after it is connected. The firmware update will be downloaded to your camera within 24 hours. When the LED light on the Petcube will start blinking green rapidly (fig 4.1.14), do not disconnect your device. The installation only takes around 5 minutes.

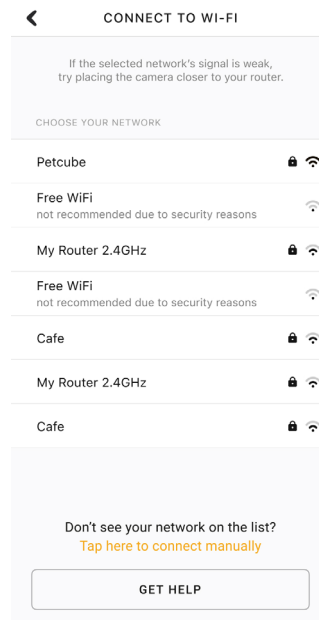

Fig. 4.1.9

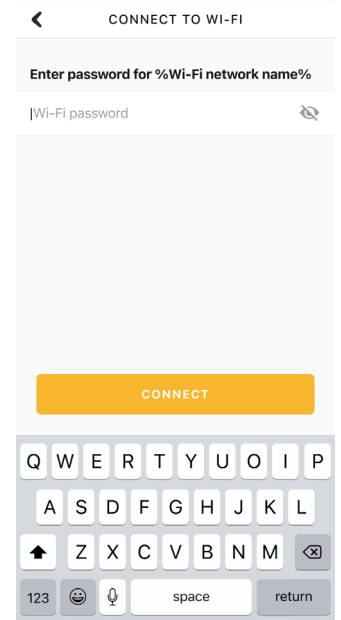

Fig. 4.1.10

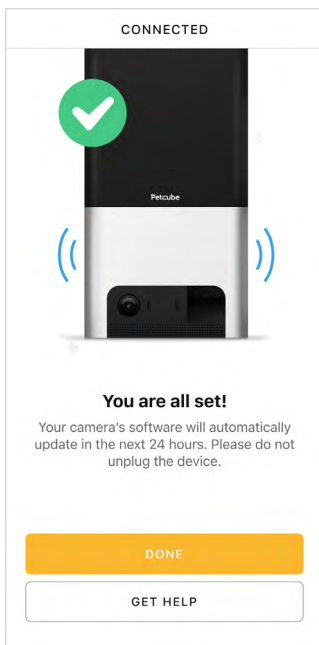

Fig. 4.1.11

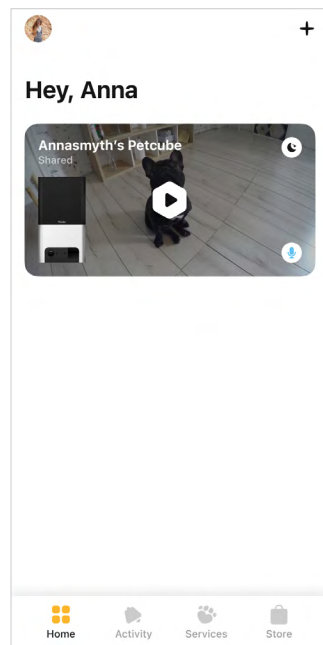

Fig. 4.1.12



Fig. 4.1.13



Fig. 4.1.14

2. Setting up your Petcube camera on Android device

Step 1. To set up your Petcube, download the Petcube app to your Android device (fig 4.2.1). The Petcube app requires Android 7.1.2 or greater and can be downloaded in the Google Play Store or at the link below:

www.petcu.be/android-app-download

Step 2. Connect your Petcube to a power source and wait up to a minute until the LED light starts pulsing green (fig 4.2.2).

Step 3. Open Petcube app on your Android device, and log in or sign up for a Petcube account (fig 4.2.3).

Step 4. Tap the 'Plus' icon in the right upper corner of the screen and pick your Petcube Bites 2 from the list of options (fig 4.2.4). Make sure to turn on the Bluetooth before you continue.

Step 5. When the LED light on the camera is blinking green, hit 'Next' (fig 4.2.6).

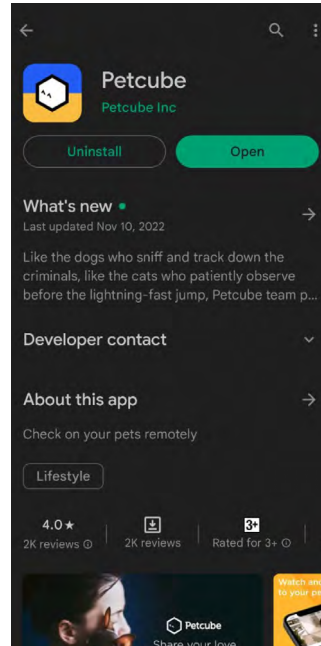

Fig. 4.2.1



Fig. 4.2.2

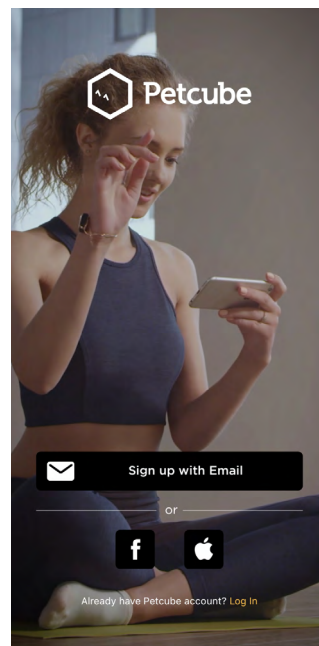

Fig. 4.2.3



Fig. 4.2.4

Step 6. To identify your device, tap 'Select'. When the light on the device blinks green rapidly, tap 'Connect' (fig 4.2.8).

Step 7. Wait for the app to exchange data with the Petcube and scan for available Wi-Fi networks, then select your home Wi-Fi network from the list (fig 4.2.9), put in your network password and hit 'Connect' (fig 4.2.10). If you don't see your home network on the list or if you're using a hidden network, connect to your home Wi-Fi by entering the name of your network and password manually and then hit 'Connect' (keep in mind that it is case sensitive).

Step 8. Your Petcube device is almost set up! Please wait until it connects and the light on the front turns white (fig 4.2.12).

Step 9. Once the LED light on your Petcube changes to solid white, you are ready to play with your Petcube (fig 4.2.13).

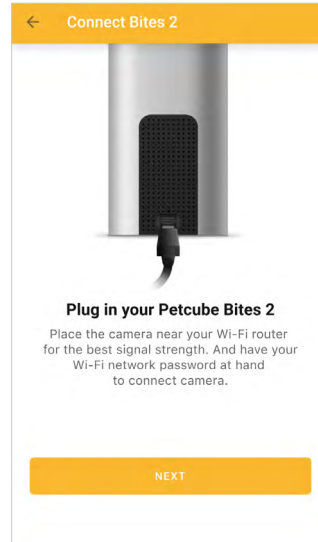

Fig. 4.2.5

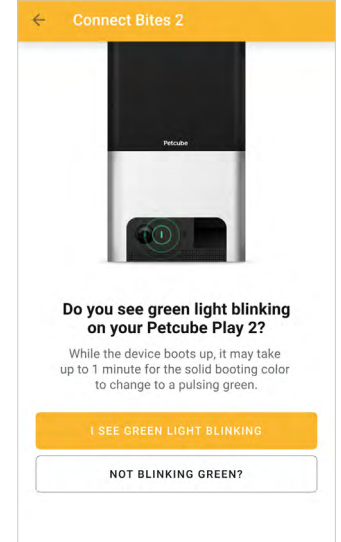

Fig. 4.2.6

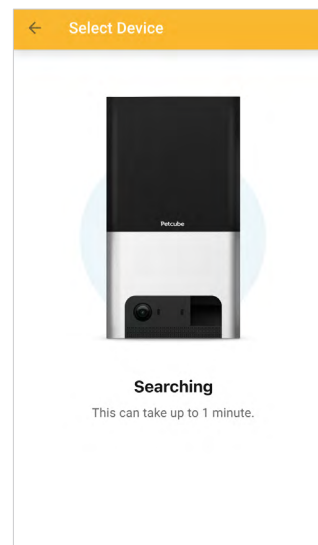

Fig. 4.2.7

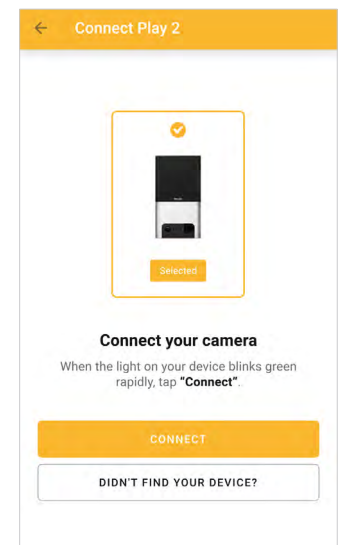

Fig. 4.2.8

Reminder: It is likely that your Petcube will need a firmware update right after it is connected. The firmware update will be downloaded to your camera within 24 hours. When the LED light on the Petcube will start blinking green rapidly (fig 4.2.14), do not disconnect your device. The installation only takes around 5 minutes.

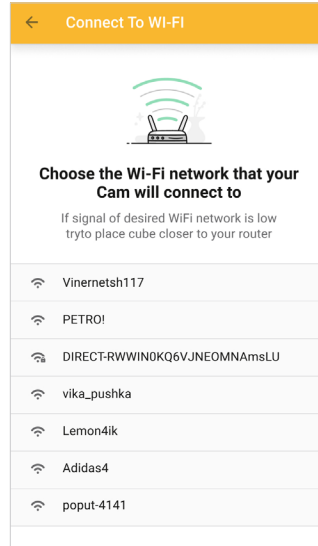

Fig. 4.2.9

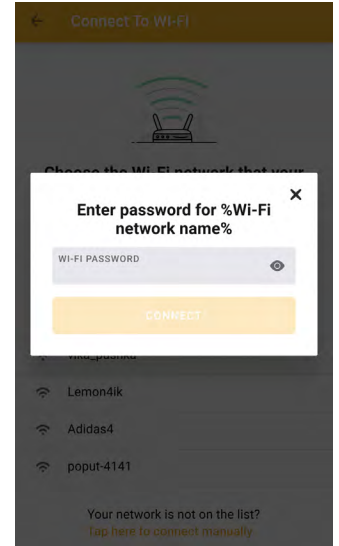

Fig. 4.2.10



Fig. 4.2.11

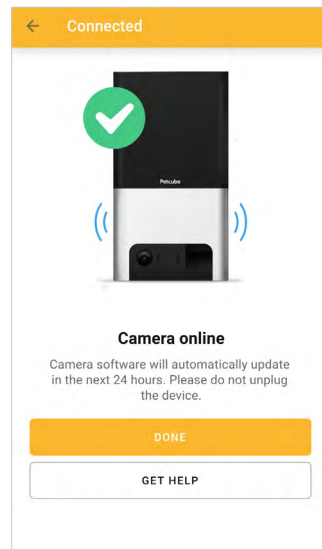

Fig. 4.2.12



Fig. 4.2.13



Fig. 4.2.14

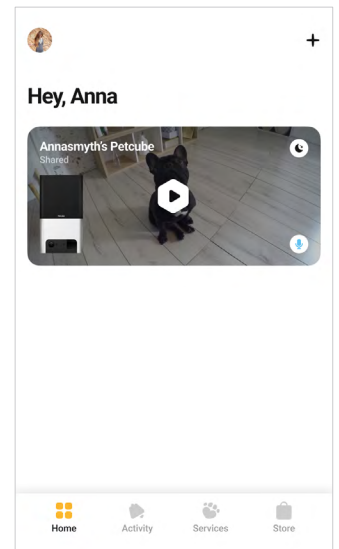

Fig. 4.2.15

3. Setting up Alexa

Once you've successfully paired the Petcube with your phone, you will be able to start using Alexa on your camera.

To install Alexa, press Amazon Alexa button below the Play icon in the center (fig 4.3.1) and tap 'Get started' below (fig 4.3.2). Log in with your Amazon account (fig 4.3.3), and Allow access to Alexa voice services (fig 4.3.4). Hit 'Next' on the language choice (currently Alexa on Petcube only supports English (fig 4.3.5)) and tap 'Done' at the last step (fig 4.3.6).

Keep in mind that you might need to wait a few minutes for Alexa to start working. If it doesn't work within 5 minutes, simply restart the Petcube app.

To turn the listening sound off, tap 'Alexa Mic On' below the Play icon in the center (fig 4.3.7) and move the slider to 'Mic Off' position (fig 4.3.8).

To disable Alexa completely, tap 'Alexa Mic On' below the Play icon (fig 4.3.7), go to Settings (fig 4.3.9) and choose 'Disable Amazon Alexa' (fig 4.3.10).

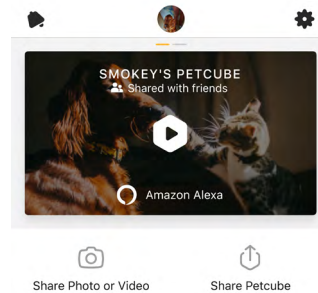

Fig. 4.3.1

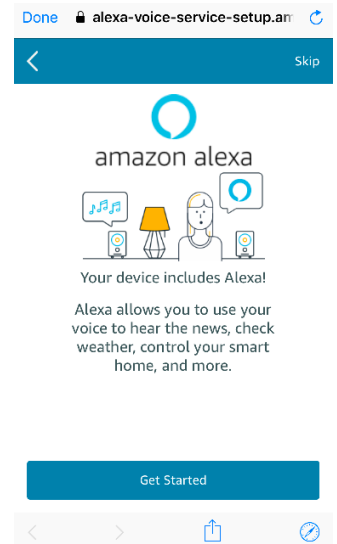

Fig. 4.3.2

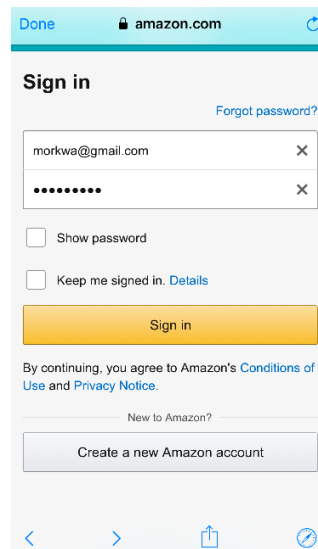

Fig. 4.3.3

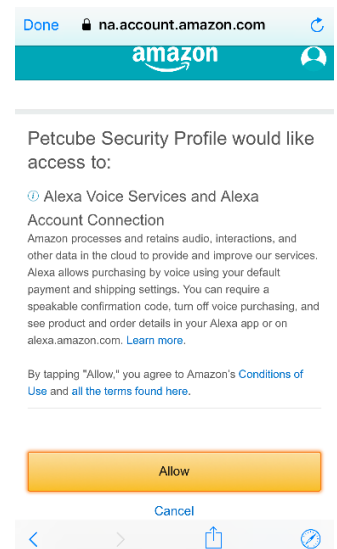

Fig. 4.3.4

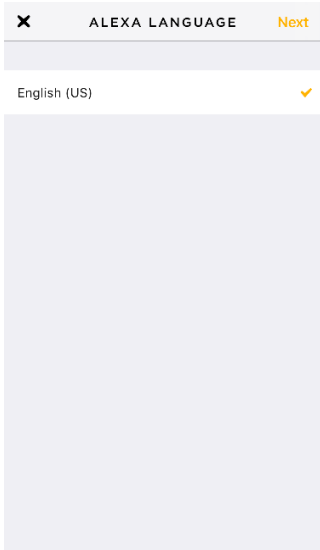

Fig. 4.3.5

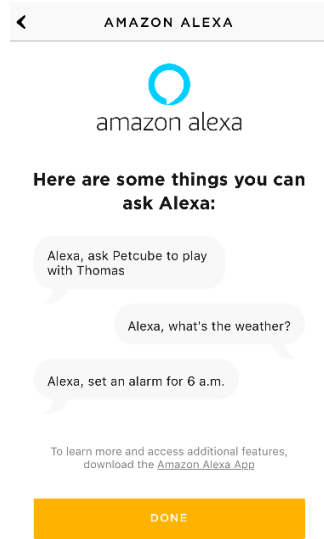

Fig. 4.3.6

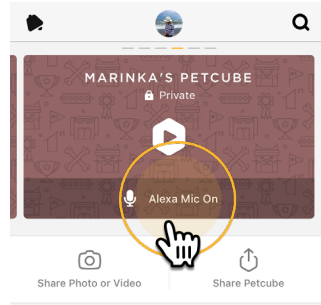

Fig. 4.3.7

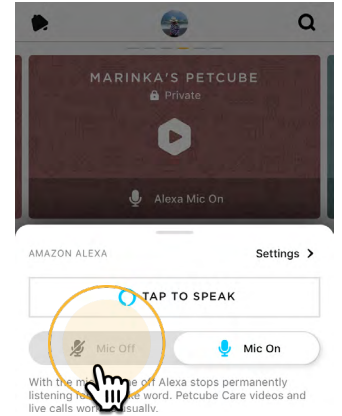

Fig. 4.3.8

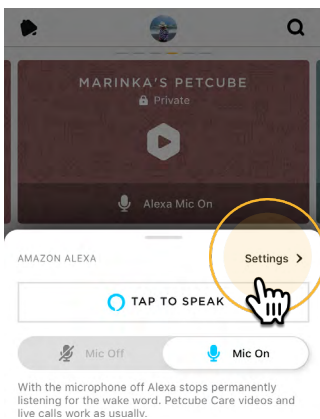

Fig. 4.3.9

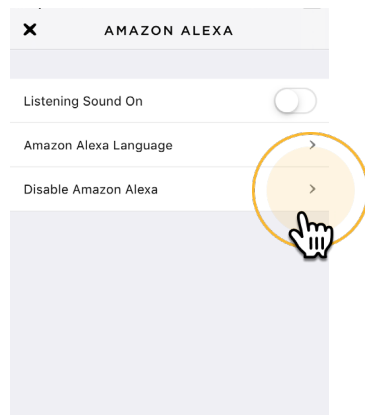

Fig. 4.3.10

4. Select the correct treat size insert

Your Petcube Bites 2 camera now comes with three different inserts to accommodate different treat sizes: Small, Medium and Large.

- Use Small insert with treats under 12mm or 0.47in of size;
- Use Medium insert with treats between 12-16mm or 0.47-0.63in of size;
- Use Large insert with treats above 16mm or 0.63in of size.

Keep in mind that if the treats you're using have an unnatural form (a star or a bone), for the best experience it is recommended to use the insert 1 size bigger.

5. Playing with your Petcube

If you successfully registered your Petcube and the LED light on it glows white, tap on the camera profile on the homescreen to access camera page.

Petcube Bites 2 Live Stream Controls (fig 4.5.2):

1. Game Settings Menu;
2. Start a video to be saved on your device;
3. Take a photo to be saved on your device;
4. Dispense treats to your pet;
5. Tap to talk to your pet;
6. Tap to hear your pet;
7. Switch to portrait mode (iOS only).

To fling treats, use the bone icon (#5 on fig 4.5.2) in the bottom left corner of the app while in play mode, then hold down the bone icon in the middle of the screen and swipe up to select how far you want to fling the treats: you can select close, medium and long shots (fig 4.5.3).

To access advanced Video & Audio control, select the 'Settings' icon in the top right corner of the screen (fig 4.5.4 - 4.5.6).

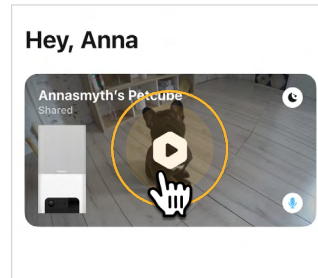

Fig. 4.5.1

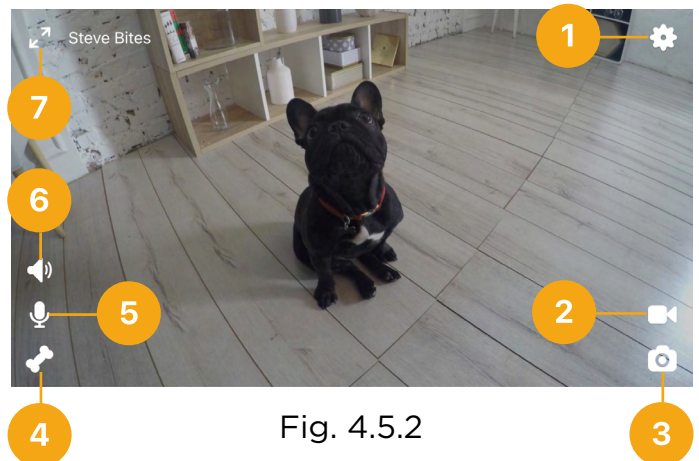

Fig. 4.5.2

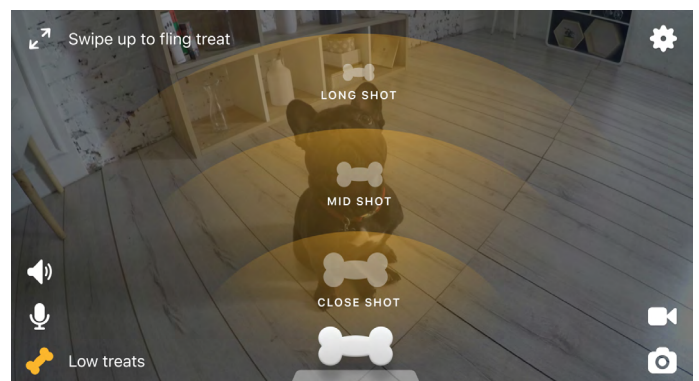

Fig. 4.5.3

To exit the live stream, first exit the landscape mode first by pressing the 2 arrows icon in the upper left corner (fig 4.5.7). To return back to the Petcube homescreen, tap the camera video while in portrait mode and press the 'back' icon in the upper left corner (fig 4.5.8).

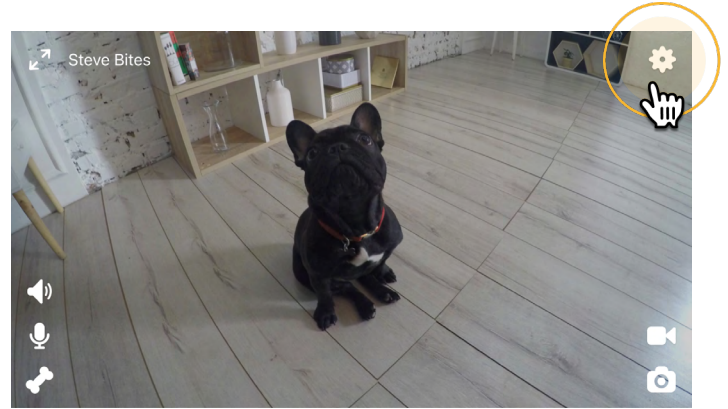

Fig. 4.5.4

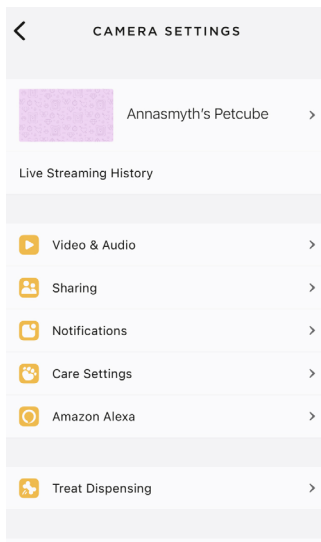

Fig. 4.5.5

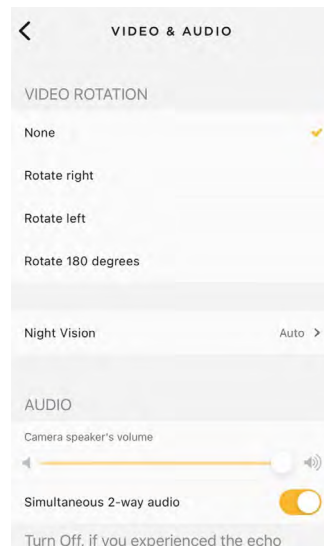

Fig. 4.5.6

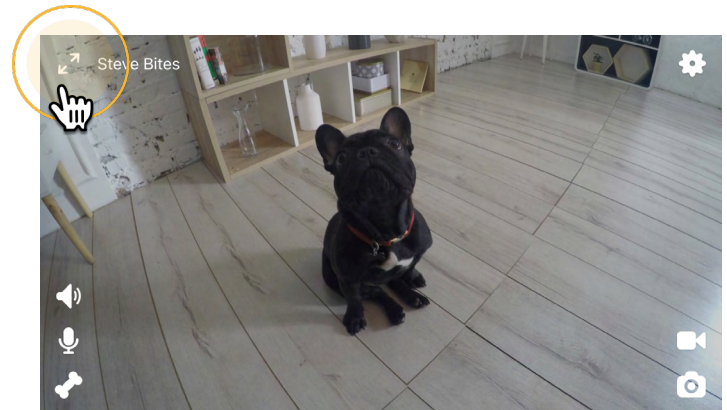

Fig. 4.5.7

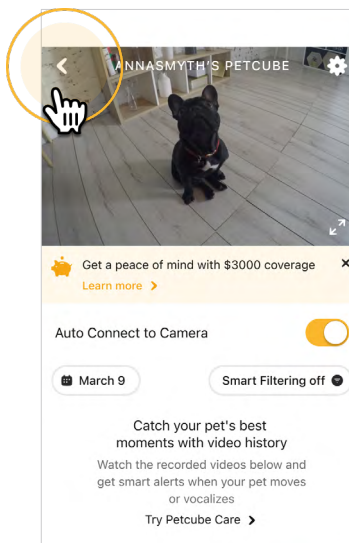

Fig. 4.5.8

6. Where to place your Petcube Bites

Consider placing Petcube Bites in a location that allows for maximum coverage through the camera's 160° wide angle lens. It's always a good idea to point the Petcube Bites in the direction where your pets tend to spend most of their time.

If you want to place Petcube Bites on a table or shelf, we recommend you set it up at least 3 feet above the floor. Petcube Bites has a non-slip rubber bottom, which provides a secure grip on flat surfaces. The camera should be placed closer to the edge of the surface for better viewing angle.

If you decide to mount Petcube Bites securely on the wall, select your preferred viewing height. Then, use the included mounting guide to mark where to drill holes and two drywall anchor screws to affix the device.

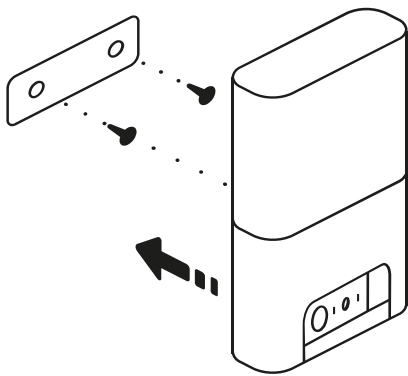

Fig. 4.6.1

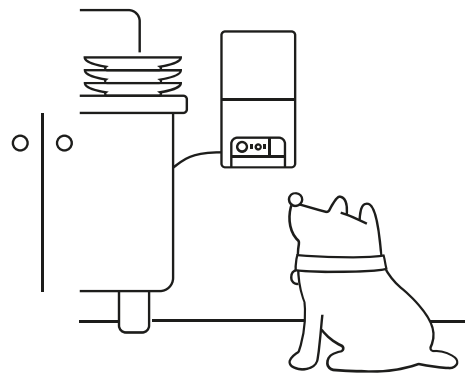

Fig. 4.6.2

7. Treat recommendations

- Treats should be uniform in size (ideally spherical), no smaller than 0.3 inches and no larger than 1 inch in length. The treat hopper can fit up to 2 lbs of treats.
- Treats must be dry and hard
- Treats should not be greasy, soft, sticky or crumbly
- Use treats that are all the same size and shape
- For smaller size treats, multiple treats may be dispensed at once

Close the container lid for an airtight seal to keep treats fresh and so no odors get out.

8. Cleaning made simple

The detachable treat container is dishwasher safe on lower temperature/delicate cleaning settings (up to 130°F), or you can wash it by hand. To detach the treat container, push the back release button to the right and pull up and away from the base.

Do not use abrasive cleaners on the container, only liquid detergents and soft sponges. To detach the treat container, push the back release button to the right and pull up and away from the base.

Do not use abrasive cleaners on the container, only liquid detergents and soft sponges.

9. Taking screenshots and recording video

In order to take a snapshot of the live stream from your Petcube, you need to tap the Photo Camera icon on the bottom left while in play mode (fig 4.9.1). To start recording a live stream, tap the Video Camera icon at the bottom right while in play mode. To stop recording, tap the 'Stop' icon and the video will automatically be saved to your phone's storage.



Fig. 4.9.1

10. Using Zoom feature

Petcube app now comes with the 4x digital zoom feature. Just connect to your Petcube in the app, pinch-to-zoom in the image during the game, and pan around to see the whole scene.

11. Using Night Vision

Petcube comes with the infrared sensor capable of streaming clear black and white video in pitch dark. When the sensor detects a low level of ambient light, your Petcube camera will automatically activate the Night Vision mode.

By default Night Vision is set to Auto mode, but you can default it to always ON or OFF going to Camera Settings -> Audio & Video

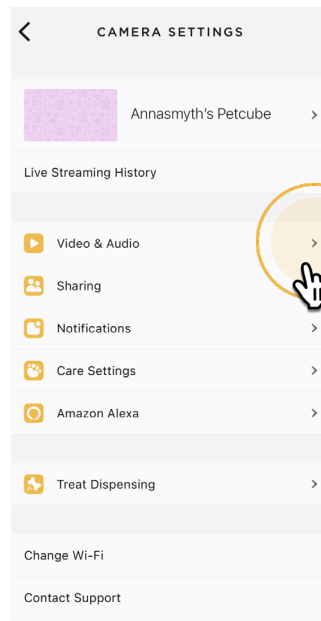

Fig. 4.11.1

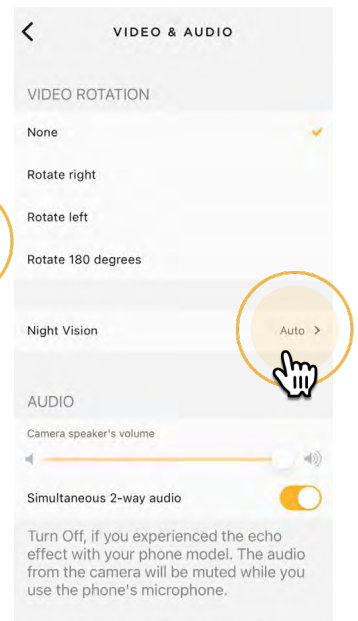

Fig. 4.11.2

12. Using Push-To-Talk or Two-way Audio

Petcube comes with 2 ways of audio interaction: default simultaneous 2-way audio and optional 'push-to-talk' feature that works much like a walkie-talkie.

To start talking and listening, first, make sure the sound is activated in Settings at the top right, then simply tap the mic icon in the bottom left corner.

To switch to push-to-talk audio:

1. Open the Petcube app;
2. Go to the camera profile, tap the 'Settings' wheel in the upper right corner if you use Android or tap the 'Play' icon if you use iOS;
3. Tap the 'Settings' wheel in the upper right corner;
4. Select 'Video & Audio' and disable the 'Simultaneous 2-way audio'.

13. Volume control

To configure the volume level on your Petcube:

1. Open the Petcube app;
2. Go to the camera profile (fig 4.13.1);
3. Tap the 'Settings' wheel in the upper right corner;
4. Go to Video & Audio settings menu (fig 4.13.3);
5. Adjust the volume level under 'Camera Sound' (fig 4.13.4).

Keep in mind that in order to be able to change the settings on your Petcube, it needs to be in online standby mode (steady white light).

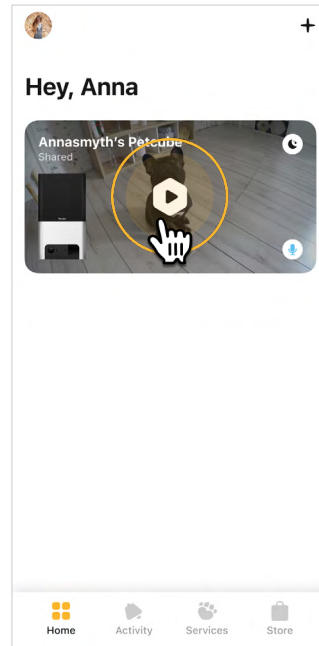

Fig. 4.13.1

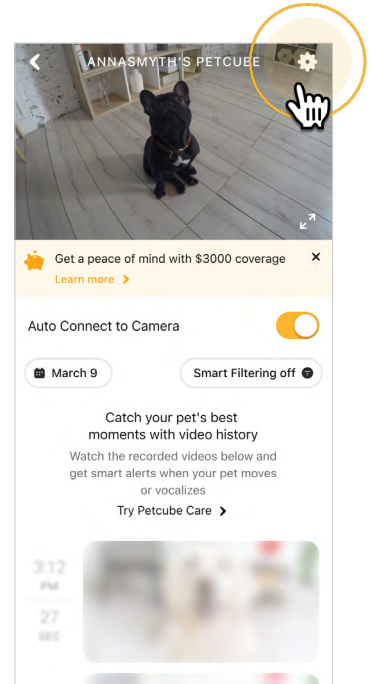

Fig. 4.13.2

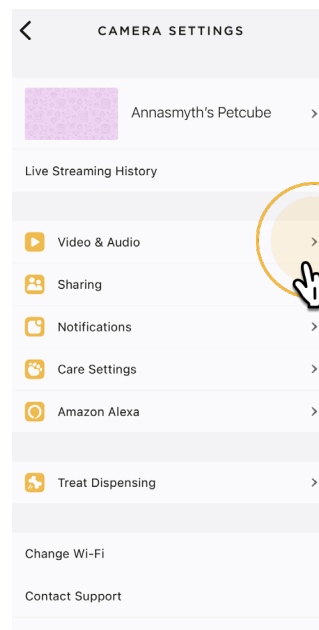

Fig. 4.13.3

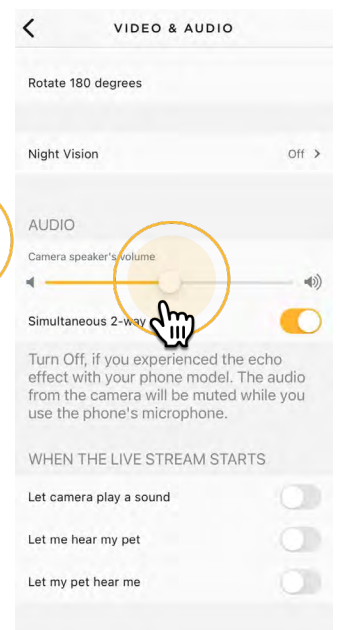

Fig. 4.13.4

14. Sound alert at the start of a call

To attract your pet's attention and be aware of when someone connects to your Petcube in accordance with your sharing settings, at the start of every call your Petcube will play a sound alert.

To disable the sound alert:

1. Open the Petcube app;
2. Go to the camera profile;
3. Tap the 'Settings' wheel in the upper right corner;
4. Go to Video & Audio settings;
5. Switch the 'Let camera play a sound' to off (fig 4.14.1).

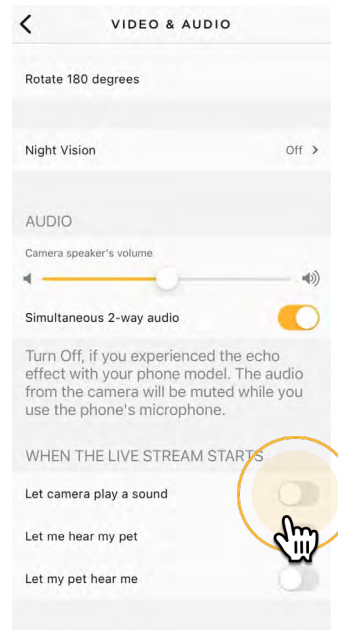

Fig. 4.14.1

15. Sharing access to your Petcube Bites 2

By default, only you can access your Petcube video stream, but you can share access to your Petcube with your family, friends and anyone who installs the Petcube app on their smartphone.

Family members (fig 4.15.4) will have almost full control of your camera, being able to connect to your Petcube anytime, change camera and sharing settings and access recorded videos on Petcube Care timeline.

Friend sharing (fig 4.15.4) allows you to set friend sharing access at specifically scheduled times and days as well as set a permission access for the treats and 2-way audio controls.

To share access to family members or friends:

1. Open the Petcube app;
2. Go to the camera profile;
3. Tap the 'Settings' wheel in the upper right corner;
4. Tap 'Sharing', select the preferable sharing option and add the new user to either 'Family' or 'Friend' list (fig 4.15.4).

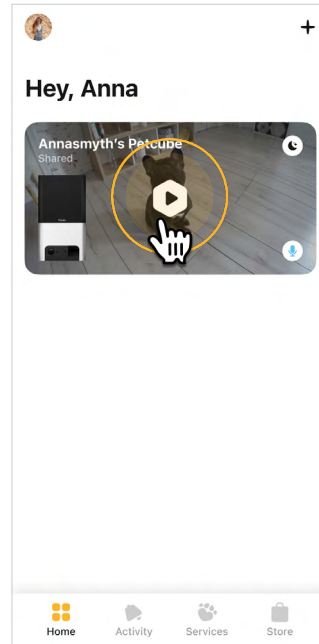

Fig. 4.15.1

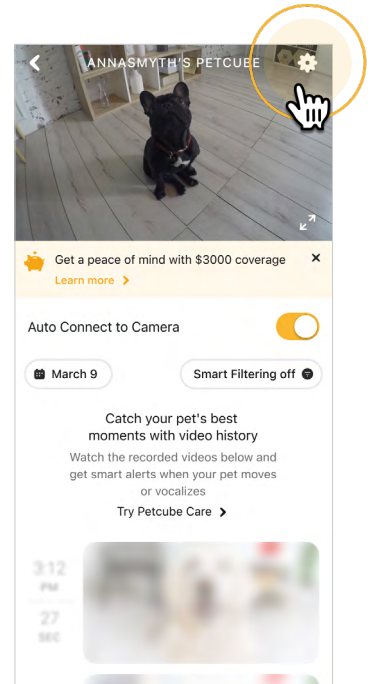

Fig. 4.15.2

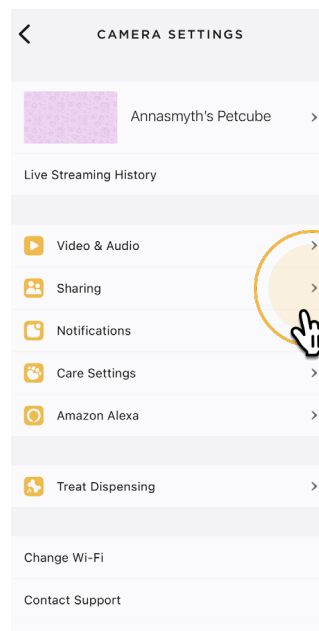

Fig. 4.15.3

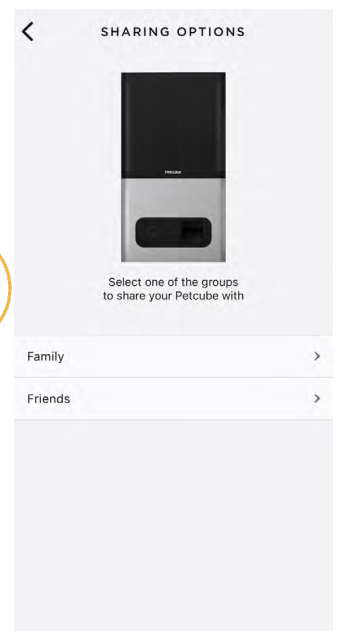

Fig. 4.15.4

To delete a user from your 'Family' or 'Friends' list:

1. Go to 'Sharing' settings again;
2. Find their username and swipe it left to 'Delete' or 'Unfriend' (fig 4.15.7 and 4.15.8).

16. Using motion and sound detection

If you are using Petcube Care cloud-based video storage service, the Petcube app can send push notifications to your smartphone whenever motion or sound is detected on your Petcube.

To enable push notifications:

1. Open the Petcube app;
2. Go to the camera profile, tap the 'Settings' wheel in the upper right corner;
3. Select 'Notifications' (fig 4.16.3);
4. Turn 'Motion Detection' and 'Sound Detection' options On (fig 4.16.4).

You can also adjust the sensitivity of the motion and sound detection sensors by moving the 'Motion sensitivity' slider (fig 4.16.5).

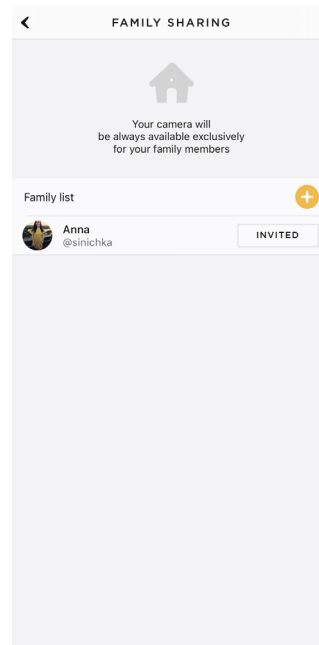

Fig. 4.15.5

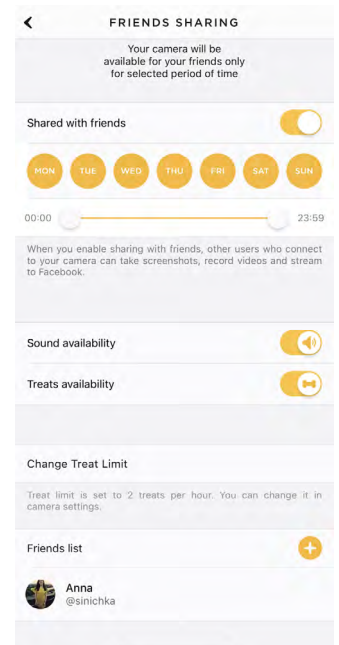

Fig. 4.15.6

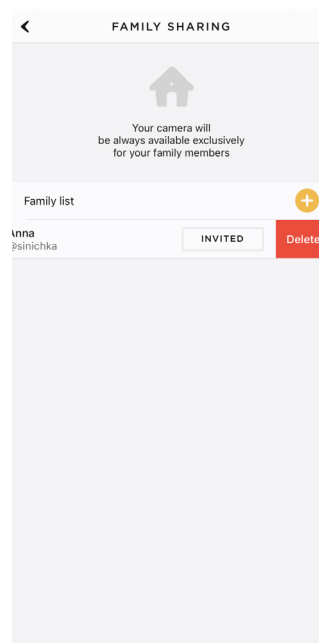

Fig. 4.15.7

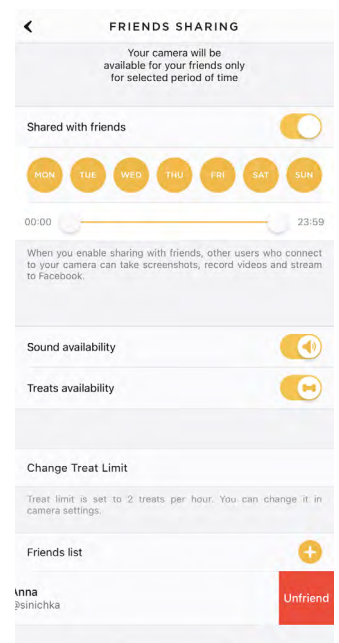

Fig. 4.15.8

Keep in mind that in order to be able to change the settings on your Petcube, it needs to be in online standby mode (steady white light).

If you are using Petcube Care cloud history service, the Petcube app will record videos triggered by motion and sound detection and you can configure push notifications to be sent as soon as new video recordings are available, enabling 'Care Video Recording' setting (fig 4.16.6).

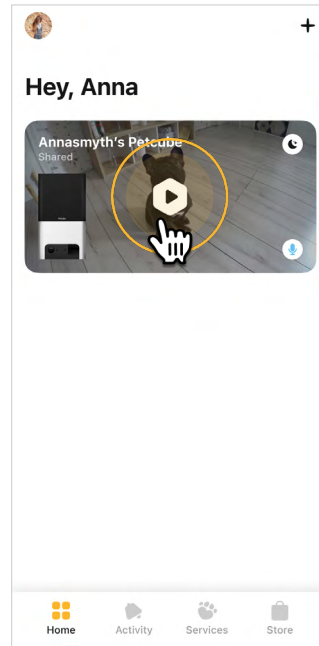

Fig. 4.16.1

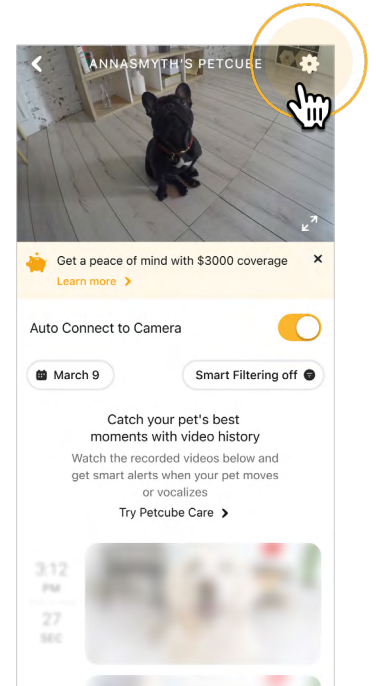

Fig. 4.16.2

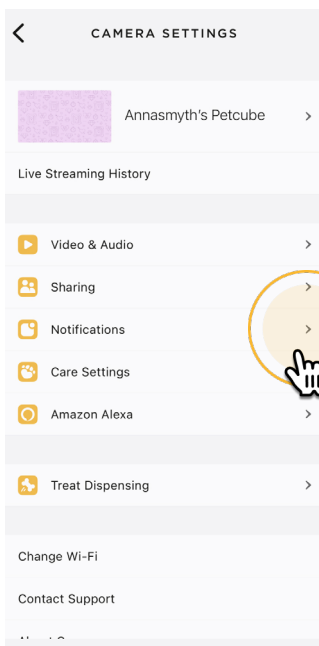

Fig. 4.16.3

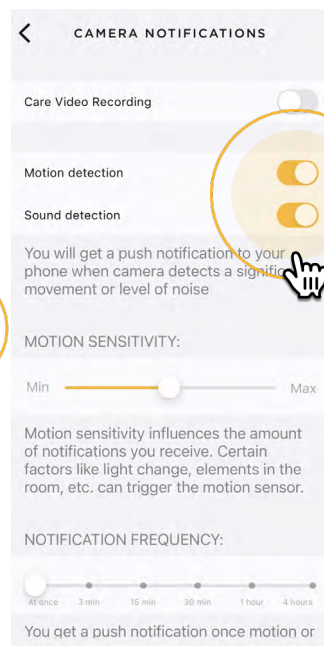

Fig. 4.16.4

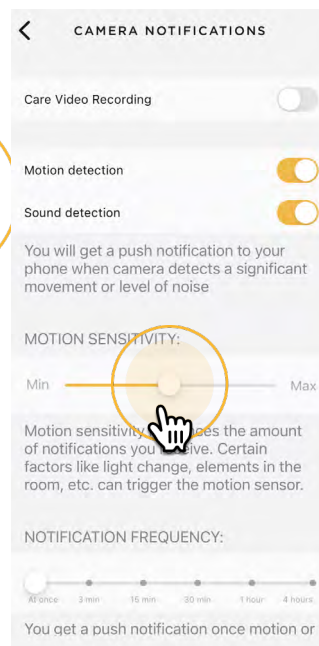

Fig. 4.16.5

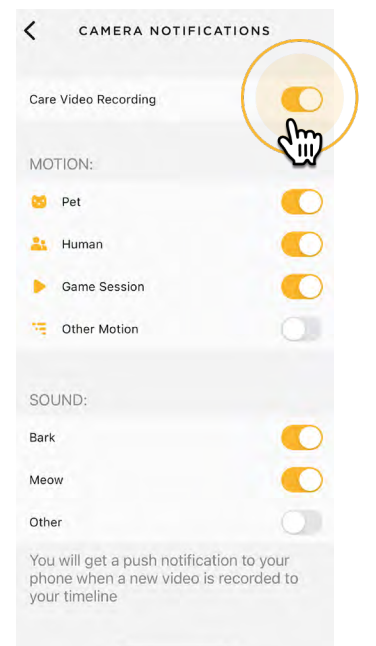

Fig. 4.16.6

17. Using Auto Treat Scheduling

With Petcube Bites users not only can give their pet a treat on demand during the live stream but also set up an auto treats schedule to cheer up their pet even if they are not there.

You can set up the treat scheduling by following these few easy steps:

1. Open the Petcube app;
2. Go to the camera profile (fig 4.17.1);
3. Tap the 'Settings' wheel in the upper right corner (fig 4.17.2);
4. Select 'Treat Dispensing' (fig 4.17.3);
5. Set time, treat flinging power and serving count and when the time comes, your pet will be getting that extra treat (fig 4.17.4).

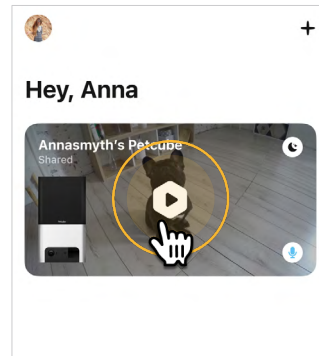

Fig. 4.17.1

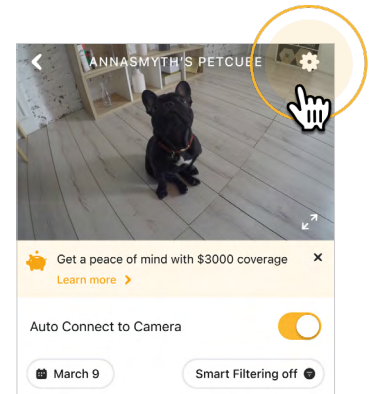

Fig. 4.17.2

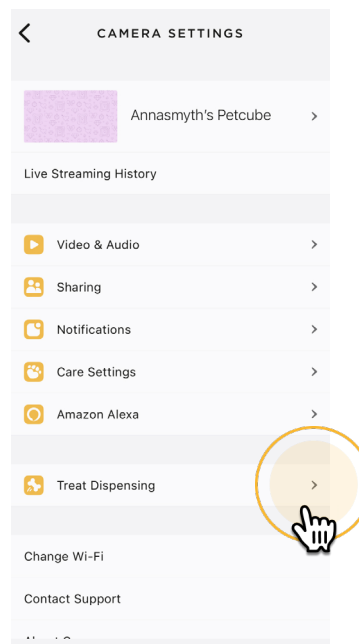

Fig. 4.17.3

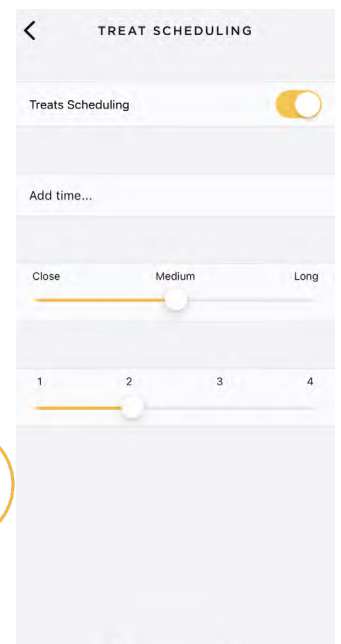

Fig. 4.17.4

18. Setting up multiple Petcube cameras to one account

To register multiple cameras in a single account:

1. Launch the Petcube app;
2. Click “Plus” icon in the right top corner;
3. Select your Petcube in the list and follow the instructions.

Repeat this process to register additional devices.

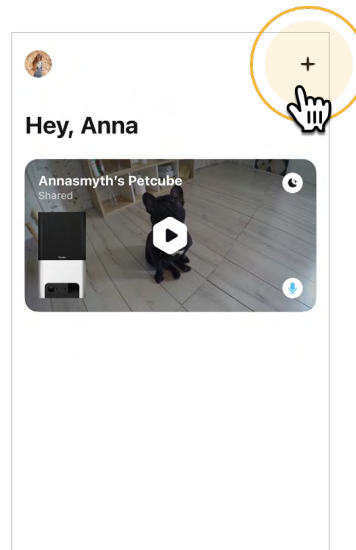

Fig. 4.18.1

19. Registering Petcube to a different account

Be aware that a Petcube can only be registered to one user. You cannot register it under multiple accounts, but you can share access to it with other users using various sharing options.

If you need to register a Petcube to a different account, simply delete the camera from the account it is currently registered to:

1. Open the Petcube app;
2. Go to the camera profile, tap the ‘Settings’ wheel in the upper right corner;
3. Find and Tap on ‘Disconnect camera’;
4. Now login to a different Petcube account and add Petcube Bites 2 to this account.

20. Deleting the Petcube device

To delete the Petcube from your account:

1. Open the Petcube app;
2. Go to the camera profile;
3. Tap the 'Settings' wheel in the upper right corner and tap 'Disconnect camera' (fig 4.20.1);
4. Confirm by choosing 'Delete'.

21. Resetting user account password

If you forgot your password:

1. Open the Petcube app on your mobile device;
2. Tap 'Log In' at the bottom of the screen (fig 4.21.1);
3. Tap 'Forgot password';
4. Tap 'Forgot password' (fig 4.21.2);
5. Enter your Petcube account email address;
6. Hit 'Restore' at the bottom (fig 4.21.3);
7. Check your email and follow the instructions to reset your password.

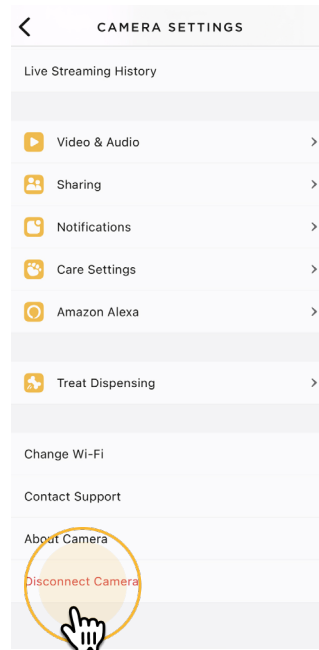

Fig. 4.20.1

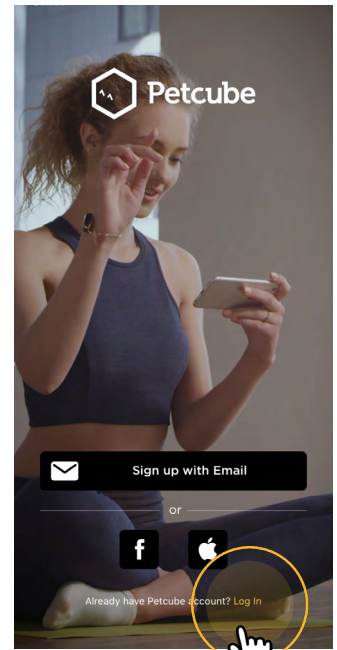

Fig. 4.21.1

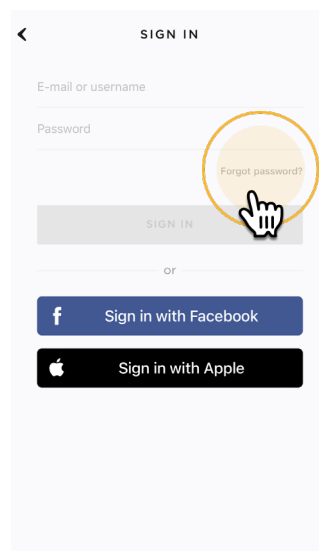

Fig. 4.21.2

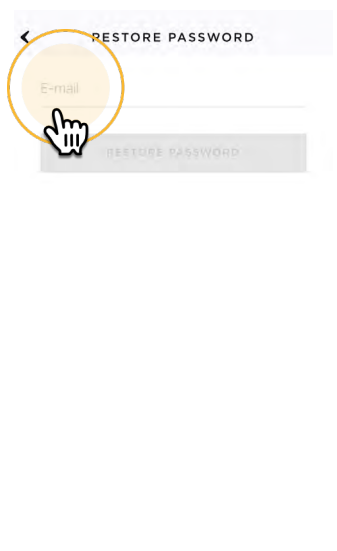

Fig. 4.21.3

22. Changing your account name, username, password or camera name

To change your account details such as your name, username or password:

1. Open the Petcube app;
2. Go to the user profile by tapping your user icon (fig 4.22.1);
3. Tap the 'Settings' wheel in the upper right corner (fig 4.22.2);
4. Hit 'Edit profile' (fig 4.22.3) and tap the values you want to change.

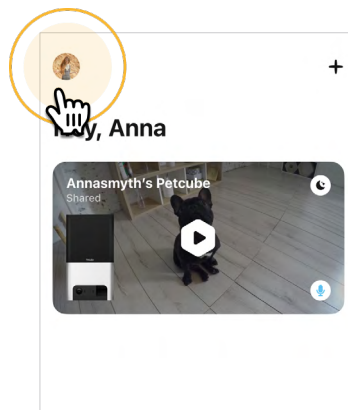

Fig. 4.22.1

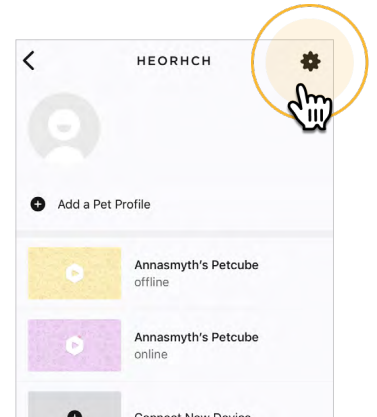

Fig. 4.22.2

To change your Petcube camera name or change the camera background:

1. Open camera profile (fig 4.22.4);
2. Tap the 'Settings' wheel in the upper right corner (fig 4.22.5);
3. Hit the arrow next to your Petcube name (fig 4.22.6) and status and change the necessary values.

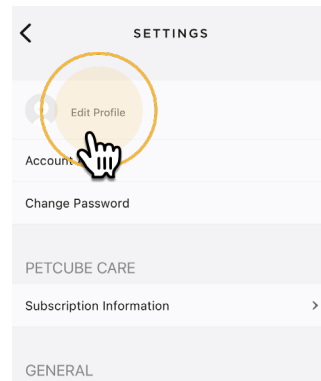

Fig. 4.22.3

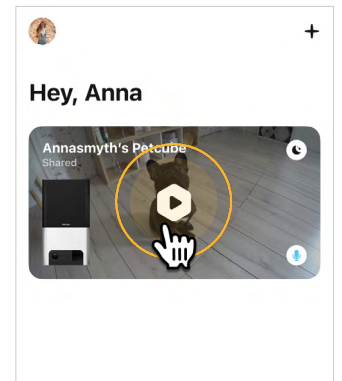

Fig. 4.22.4

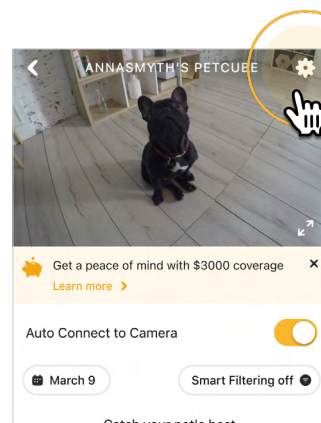

Fig. 4.22.5

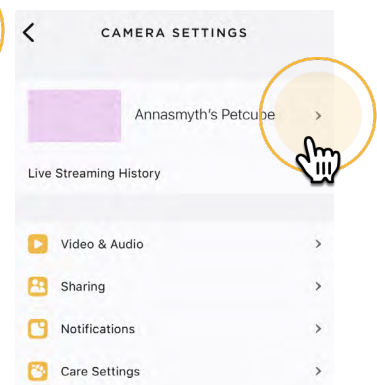

Fig. 4.22.6

23. Moving your Petcube to a different location or changing Wi-Fi settings

As long as the Petcube is within range of your wireless network, you can reposition it according to your needs.

However, if you're trying to use it in a different Wi-Fi environment or want to connect the camera to a different wireless network, you need to change the Wi-Fi settings in the Petcube app.

To do that:

1. Open the Petcube app;
2. Go to the camera profile (fig 4.23.1);
3. Tap the 'Settings' wheel in the upper right corner (fig 4.23.2);
4. Tap 'Change Wi-Fi' (fig 4.23.3) ;
5. Power up your Petcube, wait 1 minute until it starts up;
6. Find a pen or pencil, find the small hole above the USB port on the left side of the device, insert the reset pin into it, hold it down for 3 seconds until the light turns green and follow the steps on your screen.

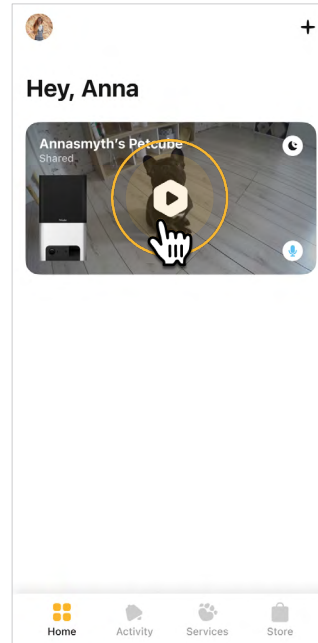

Fig. 4.23.1

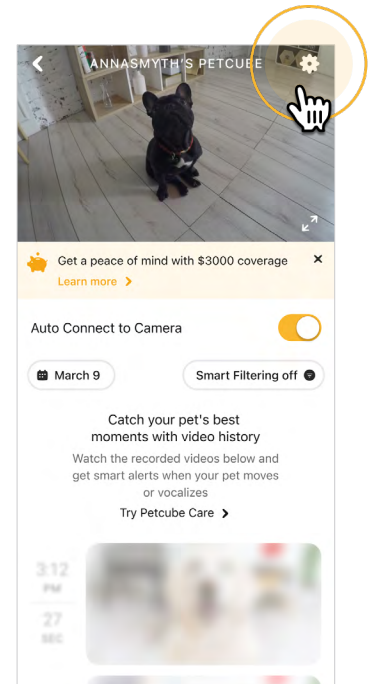

Fig. 4.23.2

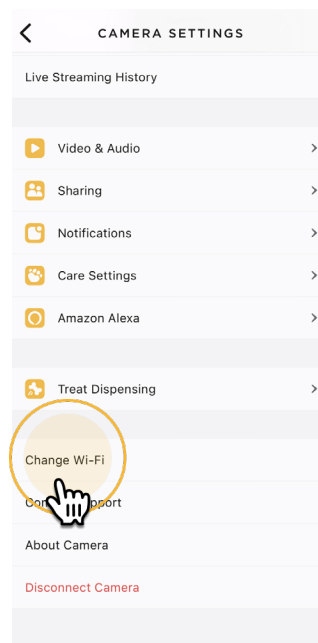

Fig. 4.23.3

5

WHAT IS AMAZON ALEXA AND HOW DOES IT WORK WITH PETCUBE

1. What is Amazon Alexa

Alexa is a smart voice-enabled personal assistant developed by Amazon. It was first used in Amazon's Echo and Echo Dot devices and is now available in a range of many other smart home gadgets. New generation Petcube devices Petcube Play 2 and Petcube Bites 2 feature Amazon Alexa built-in while only Alexa skill can be installed on previous generation cameras such as Petcube Bites, Petcube Play and Petcube Camera (don't come with Alexa built-in).

For more information on how to setup the Petcube skill for Alexa, search for 'Petcube' in 'Alexa Skills' department on [Amazon.com](https://www.amazon.com)

2. How to setup Amazon Alexa

To install Alexa, press Amazon Alexa button below the Play icon in the center (fig 5.2.1) and tap 'Get started' below (fig 5.2.2). If you have an Amazon app on your phone, you will be prompted to give Petcube access or you'll be asked to log in with your Amazon account (fig 5.2.3) if you don't have an Amazon app, then Allow access to Alexa voice services (fig 5.2.4). Hit 'Next' on the language choice (currently Alexa on Petcube only supports English) (fig 5.2.5) and tap 'Done' at the last step (fig 5.2.6).

Keep in mind that you might need to wait a few minutes for Alexa to start working. If it doesn't work within 5 minutes, simply restart the Petcube app.

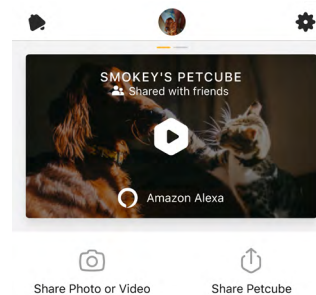

Fig. 5.2.1

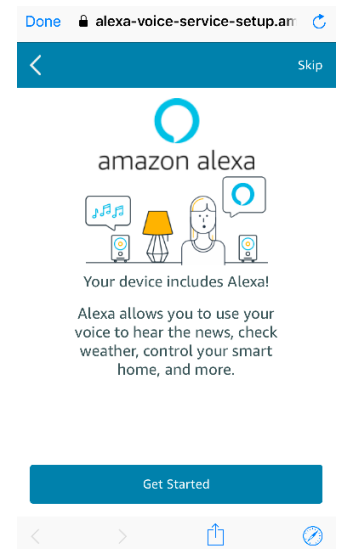

Fig. 5.2.2

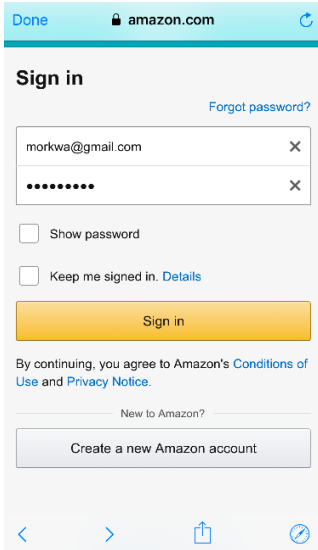

Fig. 5.2.3

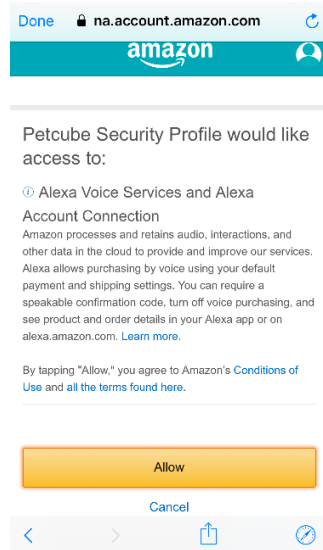

Fig. 5.2.4

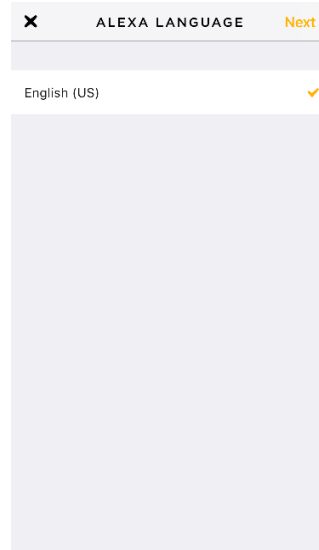

Fig. 5.2.5

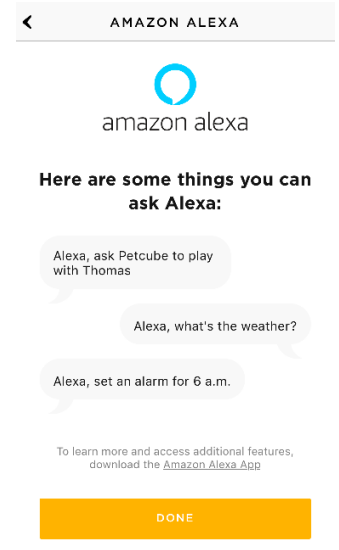

Fig. 5.2.6

3. How to disable listening on Amazon Alexa

To turn the listening sound off, tap 'Alexa Mic On' below the Play icon in the center (fig 5.3.1) and move the slider to 'Mic Off' position (fig 5.3.2).

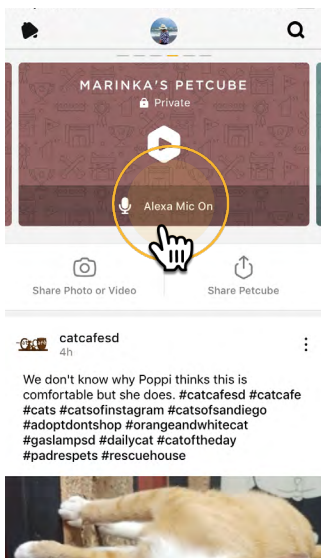

Fig. 5.3.1

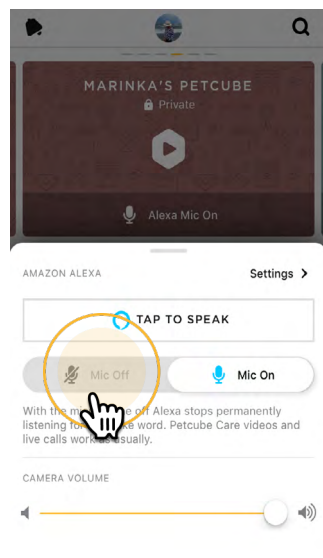

Fig. 5.3.2

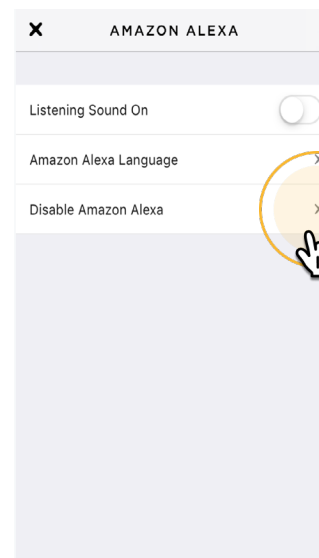

Fig. 5.3.3

4. How to setup Amazon Alexa skill

1. Sign into your Amazon Alexa account using Alexa app on your phone (fig 5.4.1)
2. Search for and download the Petcube Skill for Alexa (fig 5.4.2 and 5.4.3)
3. Link your Petcube account using your Petcube username through your Alexa App or Amazon account (fig 5.4.4)
4. Start using Alexa to give voice commands to Petcube cameras

Setting up the Petcube Skill for Amazon Alexa is a one-time process. No changes are necessary from within the Petcube app or your Petcube account.

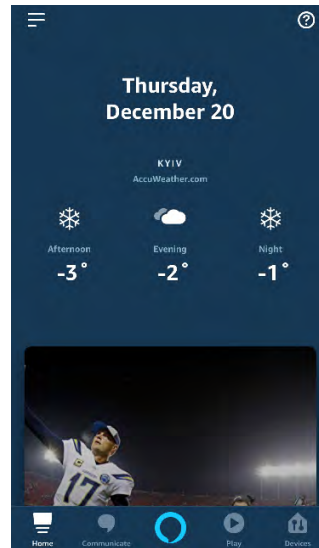

Fig. 5.4.1

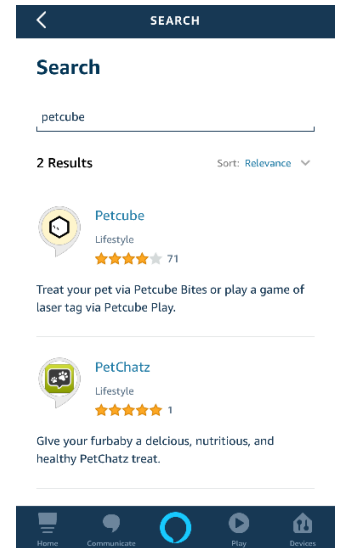

Fig. 5.4.2

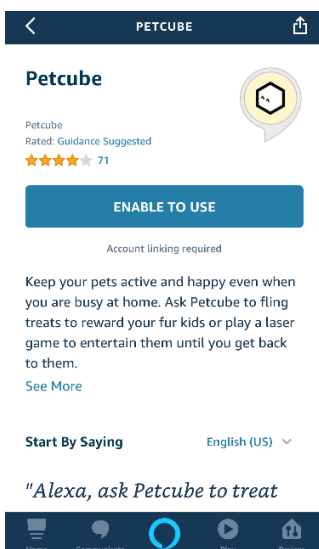

Fig. 5.4.3

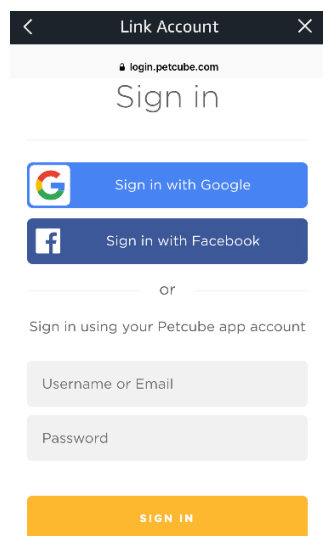

Fig. 5.4.4

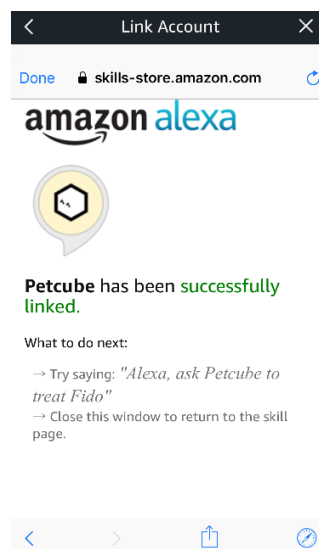

Fig. 5.4.5

5. Amazon Alexa voice commands on Petcube

After you've downloaded and installed the skill, use the following voice commands with Alexa on your Petcube Bites camera:

- Alexa, ask Petcube to treat [your pet's name]
- Alexa, ask Petcube to treat my pet
- Alexa, ask Petcube to fling treats

Note: After You say an Alexa Skill phrase (above), Alexa will respond with a phrase like "Here you go!, Yummy!, etc."

Note that using the Petcube Skill for Amazon Alexa is completely optional and your Petcube cameras will work without Alexa via the Petcube app.

Amazon, Kindle, Echo, Alexa, Dash, Fire and all related logos are trademarks of Amazon.com, Inc. or its affiliates.

1. What is Petcube Care

Petcube Care is an optional subscription service that adds features to a Petcube camera and gives owners additional peace of mind when it comes to their pets and their property.

Depending on the subscription plan, Petcube Care provides Petcube users with access to extended cloud-based video history for 3 or 90 days, longer 30-second video clips, 10 or unlimited video downloads and smart alerts.

2. How much does Petcube Care cost

Petcube Care offers two different subscription plans, Optimal and Premium, to fit the needs of pet owners of all stripes. Choose a monthly or annual rate.

For more information on the plans, check out the Petcube Care subscription options on petcube.com/care/

3. How does Petcube Care work

Petcube Care watches after your pets and home when everyone is away, capturing action videos, triggered by sound or motion. 30-second clips are saved securely in the cloud and are accessible in the interactive timeline in the Petcube app to review and download for 3 or 90 days (depending on the subscription plan). The 3-second look back lets you see what event set off the recording.

Using powerful AI technology, Care understands what pets are doing, registering important events like cat, dog or human movements, barks or meows, and sends you real-time smart alerts.

Without Care, Petcube users only have access to the live video streaming .

4. How to activate Petcube Care

To start using Petcube Care, you need to have a Petcube camera and a Petcube Care subscription.

To subscribe:

1. Go to petcube.com
2. Sign in with your Petcube account or go to the Petcube Care product page and select the most suitable subscription option for you. You will also be able to subscribe from the 'Home' page in the Petcube app on both iOS and Android devices.

If you are not a Petcube camera owner yet but wish to buy one, you will also be able to subscribe to Petcube Care when you make your purchase.

5. How to Turn Off Petcube Care Video History

Petcube Care's video history feature is turned on by default.

To deactivate it:

1. Open Petcube app ;
2. Go to the camera profile in Home menu;
3. Move the slider to 'Sleep' mode in the lower right corner of the Petcube camera controls.

In Sleep mode, Petcube Care is disabled. It will not detect and record events. Nothing will be added to your video history timeline. You will still have access to recorded videos if any were taken when Care was active and your subscription plan allows.

Use Awake mode, when you are not around and want Petcube Care to be active. You will get noise & motion notifications. These moments will be stored on your timeline.

6. How to view your video history in Petcube Care

It's very easy to access your video history with Petcube Care! Launch the Petcube app on your phone.

Tap on 'Show Older Videos' to move back or forward in time.

Tap on the '...' next to each video to get options to Delete, Share, or Save the video.

You can also access your video history if you log into your Petcube account on petcube.com in the upper right corner.

The website doesn't offer live streaming or alerts, but you can scroll through, filter, and play back the recorded Care videos.

Remember, Petcube Care records videos to the timeline automatically by default. If you would like to deactivate this feature, review these instructions in the article 'How to Turn Off Petcube Care Video History'.

If your Petcube Care is currently set to Sleep mode, you will need to **change it to Awake mode** in order for videos to be recorded to your timeline. To do this:

1. Open Petcube app;
2. Go to the camera profile in Home menu;
3. Move the slider to 'Awake' mode.

7. How to save a video recording to your phone's internal storage

While you will be able to view video history for the past 3 or 90 days, depending on your subscription plan from the cloud via Petcube Care, you will always be able to store video recordings to your phone's internal storage.

Just pick the necessary video clip, press the three dots '...' located on the left hand side of the video and select 'Save'.

8. Video recording length

Currently, video recording length can be no longer than 30 secs. So, for instance, if there's a motion that lasts for 2 minutes 15 seconds, the app will cut it into 5 scenes.

9. How can I use Petcube Care on multiple Petcube devices

At the moment, Optimal Care plan covers one camera per subscription, while Premium, both monthly and annual plans, are applied on the account level and cover an unlimited amount of cameras on the account.

10. How to add or update your payment information for Petcube Care

If you need to add or update your payment information for Petcube Care service:

1. Log into your Petcube account at petcube.com by clicking on the Home icon in the upper right corner.
2. Once logged in, go to 'Billing' tab to update your information.

11. How do I cancel Petcube Care subscription

In order to cancel your Petcube Care subscription:

1. Open Petcube app
2. Go to camera profile on which you wish to cancel the subscription
3. Tap the 'Settings' wheel in the upper right corner
4. Select Care Settings
5. Click on the current subscription at the top
6. Hit Cancel subscription at the very bottom of the page.

Alternatively, you can go to petcube.com, select the Home icon in the upper right corner, go to Petcube Care tab, select your subscription and hit Cancel Subscription.

7

PETCUBE SMART ALERTS

1. What are Smart Alerts & How do they work?

Smart alerts bring AI-powered recognition technology to the pet space. Your Petcube camera will be able to give you better intel on what's happening at home when you're away, with audio detection of dog barks and cat meows, and visual detection of cats, dogs and people. Get push notifications on your phone when something is detected and setup automatic video recording so you can later replay what happened.

2. How well does it work?

Smart alerts improve the accuracy of your notifications, giving you less false positives. The feature is powered by artificial intelligence algorithms that learn and improve over time - this means that it will actually get smarter and smarter.

3. Can I use smart alerts?

Petcube launched smart alerts in November 2018 for subscribers to select Petcube Care tiers. To find out if smart alerts are available for your subscription plan or to start a new subscription, please view the [Petcube Care page](#).

4. Can I choose which smart alerts I receive?

Yes! Smart alerts are triggered by four new types of events that your Petcube camera can recognize:

- Dogs barking
- Cats meowing
- Pets in view of the camera
- People in view of the camera

You're in full control of which notifications you get - choose one or get them all - it's up to you.

5. How can I get smart alerts for my pets?

If you don't have a Petcube camera yet:

1. Get a Petcube pet camera!
2. Download the Petcube App for your phone or tablet from the App Store or Google Play Store;
3. Sign up for 10-day video history subscription to Petcube Care;
4. Enable Smart Alerts in the Petcube App under Camera Notifications.

If you already have a Petcube camera, but don't have Petcube Care:

1. Sign up for a 1, 3 or 10-day video history subscription to Petcube Care;
2. Enable Smart Alerts in the Petcube App under Camera Notifications.

If you have a Petcube camera and Petcube Care:

1. Easy! Enable Smart Alerts in the Petcube App under Camera Notifications.

8

TROUBLESHOOTING

1. LED light doesn't light up

If the LED light on your Petcube camera is off while the camera is plugged into the power source, try unplugging it and plugging it back in. Make sure that you are using the original power adapter that came with your Petcube and that the power cord is undamaged. If you no longer have the original power adapter, make sure to only use the ones that provide 5V/2A power.

2. Petcube blinks yellow and doesn't turn blinking green

When you plug in your Petcube before starting the registration process, it should glow solid green for a minute. Wait up to 1 minute until it starts blinking green. In case the light on the device doesn't start blinking green and remains blinking yellow, try to reset your Petcube following the steps below:

1. Find a pen or pencil, find a small hole above the USB port on the left side of the Petcube Bites (fig 8.2.1), insert the reset pin into it, hold it down for 8 seconds until the Petcube plays a sound and release it;
2. Wait until the camera boots up again and starts blinking green within 1 minute;
3. Open Petcube app, go to the 'Home' tab, select 'connect your device', pick your Petcube from the list of options and follow the steps on the screen.



Fig. 8.2.1

3. LED light is stuck on solid green color and doesn't turn blinking green

When you plug in your Petcube before starting the registration process, it should glow solid green for a minute (although it may look light green). Wait up to 1 minute until it starts blinking green. In case the light on the device doesn't start blinking and remains a solid color, please contact Petcube Customer Support team at support@petcube.com.

4. Incorrect Wi-Fi password

If Petcube app is showing the 'Incorrect Wi-Fi password' error message after the setup, here are a few possible reasons behind that:

1. Case sensitivity: check the entered password for uppercase or lowercase characters. Keep in mind that 'Password' and 'password' would be two different passwords because the "P" is uppercase in the first example and lowercase in the second example;
2. Password length: check the entered password length and keep in mind that normally the password length is 8+ characters long;
3. Keyboard language: check the onscreen keyboard language and make sure you enter password in the correct keyboard layout.

To reset the Wi-Fi password:

1. Open the Petcube app;
2. Go to the camera profile (fig 8.4.1);
3. Tap the 'Settings' wheel in the upper right corner (fig 8.4.2);
4. Tap 'Change Wi-Fi' (fig 8.4.3);
5. Power up your Petcube, wait 1 minute until it starts up;

- Find a pen or pencil, find a small hole on the bottom of the device, insert a pin into it, hold it down for 3 seconds until the light changes to pulsing green and follow the steps on your screen;

5. The LED is pulsing yellow and doesn't turn white after setup

This problem may occur if you have entered an incorrect password for your home Wi-Fi network during registration. To change it:

- Open the Petcube app;
- Go to the camera profile;
- Tap the 'Settings' wheel in the upper right corner;
- Choose 'Wi-Fi';
- Find a pen or pencil, find the small hole above the USB port on the left side of the Petcube Bites, insert the reset pin into it, hold it down for 3 seconds until the light changes to pulsing green and follow the stepson your screen.

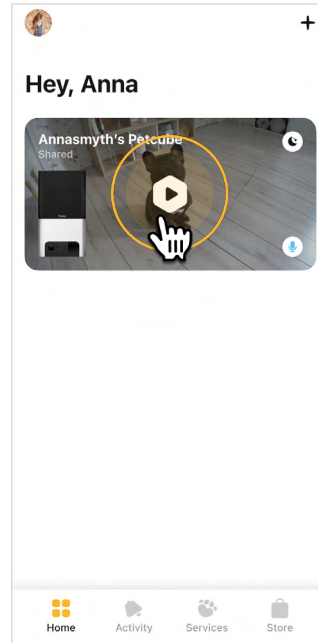

Fig. 8.4.1

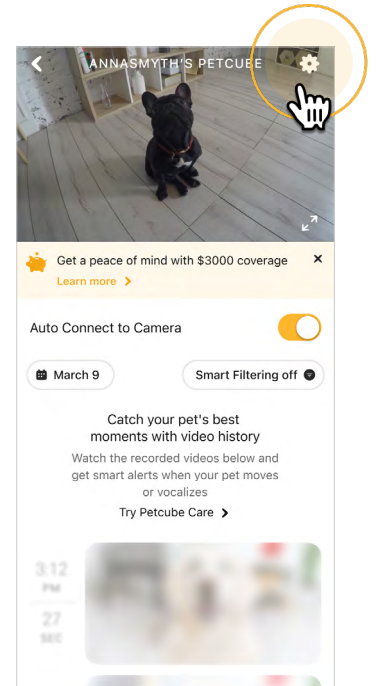

Fig. 8.4.2

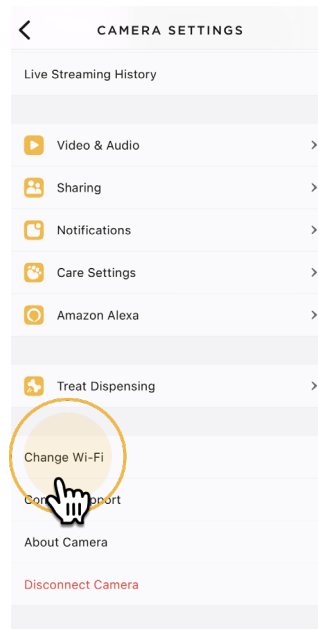

Fig. 8.4.3

If that doesn't help, below are a few other possible reasons this could be happening:

1. Your Petcube requires a manual firmware update. Please contact Petcube Customer Care Team for assistance at petcube.com/support/
2. You are using either a FIOS or Xfinity router or your router might be set up to transmit in WEP encryption mode, which is not supported by Petcube due to security reasons. Petcube works with newer WPA/WPA2 encryption technology that aims to provide stronger wireless data encryption than WEP. We recommend changing security encryption to WPA/WPA2, which won't require you to reconnect the devices back to the network or change your password. To access your router settings, you may either call your ISP or look at the bottom of your router, it usually has the login and password for the router settings.
3. Your router may have some security settings such as a firewall or MAC address filtering that don't allow Petcube to connect to the Internet. Call your ISP or Petcube Customer Care Team for assistance.
4. You have a WPS pin on your router, which works like a secondary Wi-Fi password that is not supported by Petcube due to security reasons as it is considered to be a vulnerability on the network. You may call your ISP to resolve this.

6. Petcube can't register on your Wi-Fi network

You may see this message when there Petcube cannot receive the IP address automatically using DHCP. Normally, the router should assign the IP address to your Petcube automatically but if this didn't happen, you can enter your router settings and assign the IP address to your Petcube manually. You can also contact your ISP team for help.

7. Petcube can't establish the cloud connection / No Internet connection

If you get this error message, firstly, make sure you have Internet access on your Wi-Fi by trying to open a few websites on a few devices. If you have Internet access but Petcube still can't be connected, try to reset the device by following these easy steps:

1. First, if you have previously set up your Petcube, open the Petcube app, go to 'Home' tab, then select 'Settings' and choose 'Disconnect Camera';
2. Power up your Petcube, wait 1 minute until it starts up, find a small hole at the bottom of your Petcube Play, insert the reset pin into it, hold it down for 8 seconds until the Petcube plays a sound and release it;
3. Wait until your Petcube boots up again and starts blinking green.

Open Petcube app, go to the 'Home' tab, tap on '+' icon in the top right corner, select your Petcube from the list of options and follow the steps on the screen.

If you want to have the firewall on, you need to open the following ports:

a) TCP port 3335; 34.194.225.22

b) TCP port 443; 35.212.7.2135.207.1.22 (You may not need the UDP ports because they're rarely blocked, but UDP range should be from 7000 to 7100)

WPS pin code should be disabled (please note that not all the routers have it).

MAC filtering should be disabled. If enabled, a MAC address can be found at the back of the cube.

8. The LED is pulsing orange and doesn't turn white after setup

Flashing orange LED light normally means that the device was connected to your Wi-Fi router but the router doesn't allow the Petcube to connect to the Internet. This can be because of certain security settings on your router, such as firewall or MAC address filtering. Contact your ISP or Petcube Customer Care Team for assistance.

9. Petcube cannot be found by setup

In case you are having a problem setting up your Petcube via Bluetooth, there's an alternative setup approach we suggest to try. Follow the steps below to set up your

device via Wi-Fi access point:

Power your Petcube off and back on and start the setup process over again. Keep in mind that when you first power on your Petcube camera it glows solid yellow for up to a minute (although it may look light green) so wait 1 minute until it starts blinking green. If it doesn't start blinking, find a small hole on the bottom of your Petcube Play, insert the reset pin into it and hold it down for 3 seconds until it changes to green.

Now, follow these steps:

1. Open Petcube application;
2. Go to 'Home' tab and tap 'plus' icon in the top right corner;
3. Select Petcube Camera in the list of options instead of Petcube Play;
4. Follow the steps on the screen;
5. On step 3, open 'Settings' on your phone, go to 'Wi-Fi settings', connect to Petcube Play Wi-Fi and return to the Petcube app;
6. Wait for the app to exchange data with the Petcube and scan for available Wi-Fi networks;
7. Select your home Wi-Fi network from the list, put in your network password and hit 'Join'.

If you don't see your home network in the list or if you're using a hidden network, connect to your home Wi-Fi by entering the name of your network and password manually and then hit 'Join' (keep in mind that it is case sensitive).

Once the LED light on your Petcube camera changes to solid white, you are ready to play with your Petcube.

10. Oh bummer setup error

If during the setup you're getting an 'Oh Bummer' error message, turn your Petcube off and back on, wait up to 1 minute until it boots up and starts blinking and start the setup process over again.

11. I don't see my home Wi-Fi network

This may happen if you're using a hidden Wi-Fi network. If you have a hidden network, you will be prompted to enter your network SSID and password manually.

If your Wi-Fi network isn't hidden but it still doesn't show up in the list of options, turn your Petcube off and back on, wait up to 1 minute until it boots up and starts blinking and start the setup process over again.

12. No Wi-Fi network shows up during setup

If you have an empty list of available Wi-Fi networks in the Petcube app when you need to select your home Wi-Fi network, turn your Petcube off and back on, wait up to 1 minute until it boots up and starts blinking and start the setup process over again. If the problem persists, contact Petcube Customer Care Team to determine if your Petcube needs to be updated.

13. Petcube app shows 'no treats' message

In case the Petcube app is showing an error message that says your Petcube Bites has no treats despite the container being filled with treats, simply ignore this error message and try to still fling a treat from your phone using the Petcube app.

In case it doesn't work, reboot your Petcube by unplugging it from the power source and plugging it back in.

14. Treat got stuck in the camera

If a treat gets jammed in the container, you'll get a notification via the Petcube app. You can dislodge the treat by removing it or shaking the container to empty it.

If a treat gets stuck in the flinging mechanism, use the door on the bottom of the device to remove it.

Do not unjam the device with sharp instruments or apply too much pressure, both of which can damage the device.

15. Poor video quality or poor network conditions

Like with most video streaming services and products, video quality is often affected by router performance and/or your Internet connection. This can be improved if you place Petcube closer to your home Wi-Fi router or by arranging it so there aren't any obstacles between it and your router (i.e. walls, floors, etc.).

Petcube also requires at least a 2 Mbps Internet connection upload and download speed (4 Mbps is recommended). If your Internet connection speed is less than 2 Mbps, we recommend upgrading for the best experience and highest video quality. To check your Internet speed, we recommend performing a free online speed test. If you are not getting the full speed you subscribed for, contact your Internet Service Provider.

16. I can't connect to my Petcube / Petcube is offline in the app

If you cannot connect to your Petcube from your mobile phone, try the following:

- Make sure that the LED light on the front of your Petcube is steady white. If the LED light on the front of your Petcube isn't steady white, see 'LED light notifications' to determine the issue. In most cases rebooting the Petcube by unplugging and plugging it back in should help but if you're facing this issue too often, below are a few ideas why it could be happening.

1. Your Petcube needs a firmware update. To get the most recent firmware update,

contact our support team at support@petcube.com

2. Sometimes the issue may be caused by restrictions of the Wi-Fi network your phone is connected to, especially if it's a public or office Wi-Fi. Try to temporarily disable Wi-Fi on your phone and connect to your Petcube while using mobile data or try connecting to other Public Petcube cameras in the feed to make sure it's not a network restriction issue.
3. This issue may occur if you're using a non-original or a less powerful A/C adapter. Please make sure to use only 5V / 2A power adapters.
4. You are using a mesh/merged network or your 5Ghz and 2.4Ghz channels have the same SSID. It has been observed on multiple occasions that sometimes Petcube cannot maintain a reliable connection on a mesh network or different network channels (5Ghz and 2.4Ghz) with the same network name (SSID). It is recommended to change any of the two channels names to avoid connection issues.
5. It's possible that Petcube doesn't have strong Wi-Fi connection. Keep in mind that some connection issues may be caused by poor Wi-Fi signal, which can depend on the router range, distance to the router and obstacles between Petcube and router, such as walls or radio frequency interferences. Here are a few examples how electronic appliances or bearing walls can impact your Wi-Fi signal.

Example 1 shows no electronic or radio devices and no bearing walls between two rooms so the signal in the other room is very good.

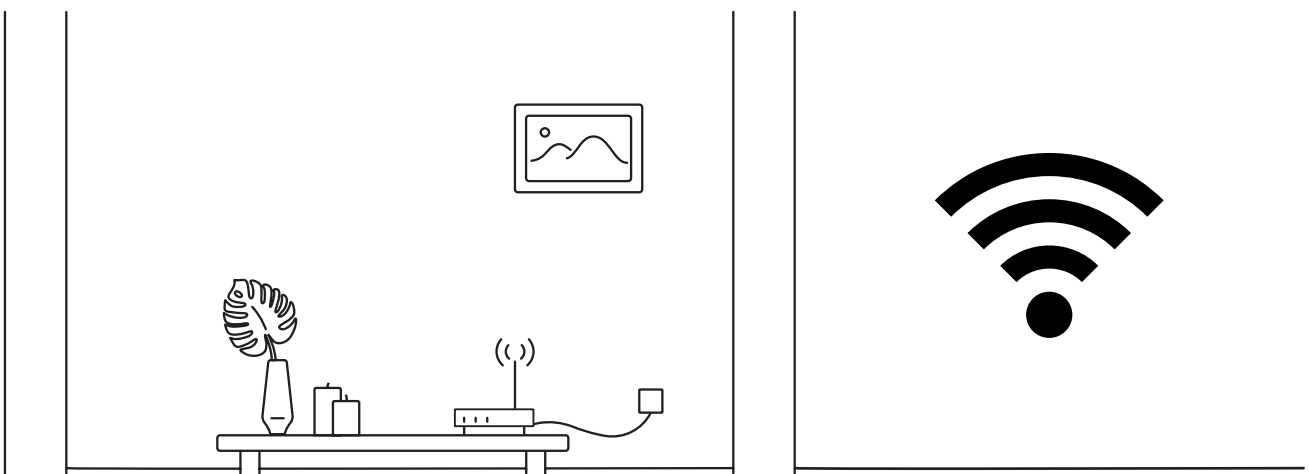

Fig. 8.17.1

Example 2 shows a bearing wall between two rooms which causes poor Wi-Fi signal in the other room.

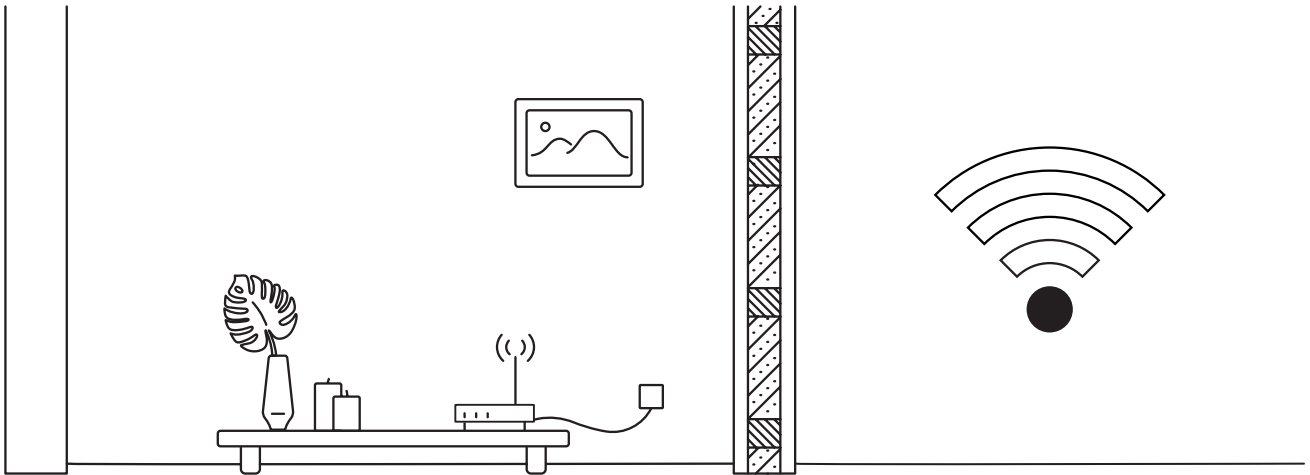

Fig. 8.17.2

Example 3 shows interference caused by radio (phone) or electronic appliances (TV). Poor Wi-Fi signal can be also impacted by microwaves, refrigerators, cordless phones, baby monitors etc.

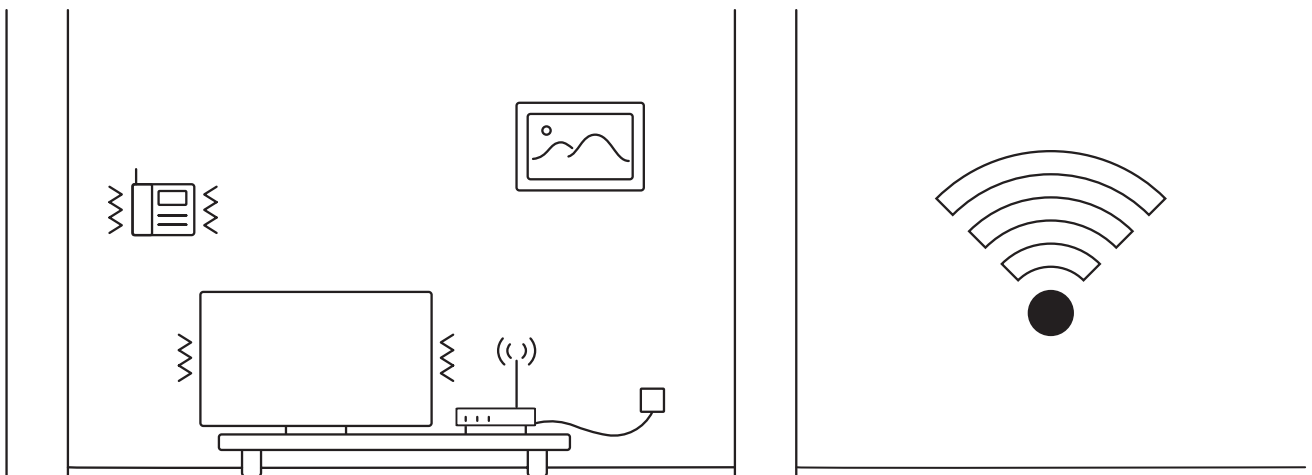

Fig. 8.17.3

17. Petcube is Disconnected in the app

If your Petcube camera status shows as 'Disconnected' in the Petcube app, it usually means that your phone is not connected to the Internet at the moment or the network you are connected to has certain restrictions. Try to switch to any other Wi-Fi network or connect to your camera using cellular data (LTE, 3G).

18. Petcube goes offline / turns off

This issue may occur if you're using a non-original or a less powerful A/C adapter. Please make sure to use only 5V / 2A power adapters.

If you're using the original adapter, but the problem persists, contact Petcube Customer Care Team to determine the problem.

29. Petcube Bites factory reset instructions

If you have a problem with your Petcube and need to reset it, follow these easy steps. First, if you have previously set up your Petcube:

1. Open the Petcube app;
2. Go to 'Home' tab;
3. Tap the 'Settings' wheel in the upper right corner;
4. Choose 'Disconnect Camera';
5. Power up your Petcube, wait 1 minute until it starts up;
6. Find a small hole below the USB port on the left side of the Petcube Bites, insert the reset pin into it, hold it down for 8 seconds until the Petcube plays a sound and release it;
7. Wait until the camera boots up and starts blinking green;
8. Open Petcube app again;

9. Go to the 'Home' tab and select 'Connect your device';
10. Pick your Petcube from the list of options and follow the steps on the screen.

20. How to find Petcube's MAC address

If your router uses MAC filtering, you need to temporarily disable it to find the MAC address of your own Petcube. This can be viewed in the list of connected devices in your router settings. Once you have its MAC address, you can safely add your Petcube as an exception and turn filtering back on.

You can also contact Petcube Customer Care Team to get help finding the MAC address of your Petcube by performing a camera test.

9

LED LIGHT NOTIFICATIONS

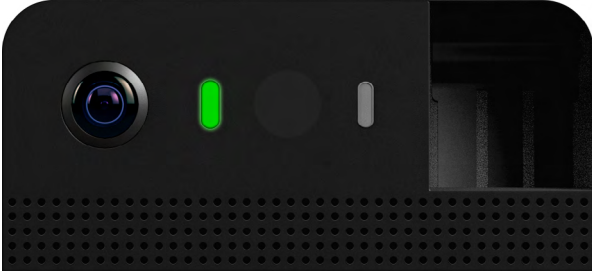

Fig. 9.1

Steady Green

If you just powered your Petcube up, it will show this color while it boots up for up to 30 seconds. If it's steady yellow during the setup, it usually takes up to a minute to complete the registration.

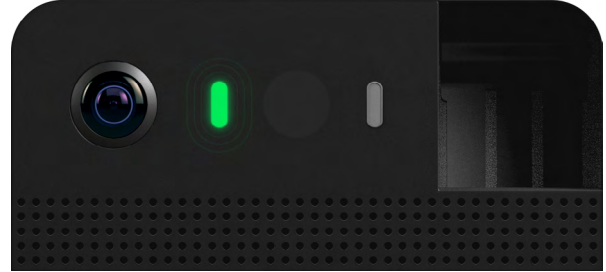

Fig. 9.2

Pulsing Green

Setup mode

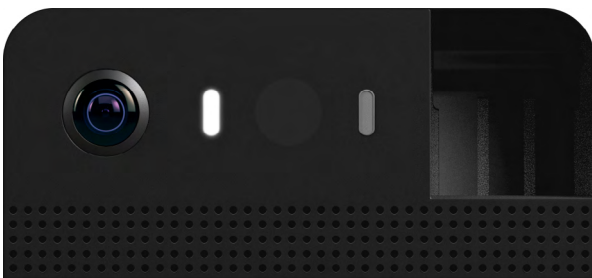

Fig. 9.3

Steady White

Online, standby mode.

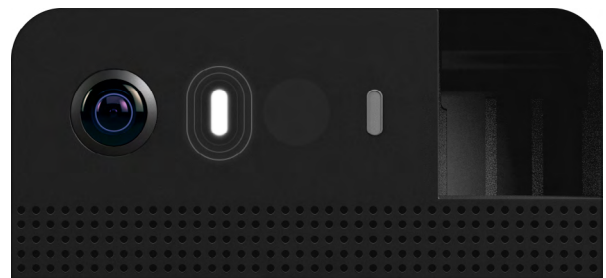

Fig. 9.4

Pulsing White

Petcube Care™ is active, saving video to your timeline

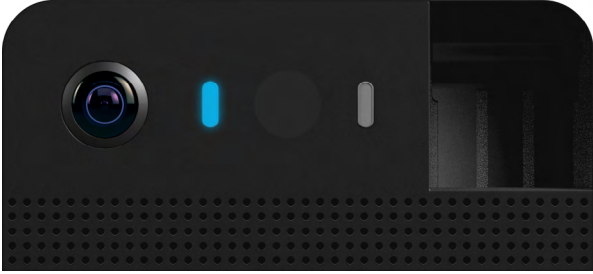

Fig. 9.5

Steady Blue

Play mode. Be aware, mind your privacy! Petcube Camera is streaming live video at the moment.

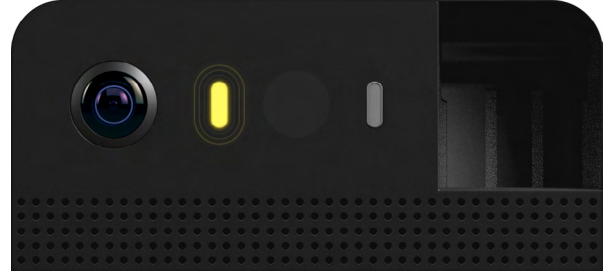

Fig. 9.6

Pulsing Yellow

Your Petcube cannot connect to your Wi-Fi network because of an incorrect password or no network not in range.



Fig. 9.7

Pulsing Orange

Your Petcube is connected to a wireless access point but cannot connect to the Internet because of the security settings on your network. Please make sure your router is not blocking the Petcube with a firewall, MAC address filtering or other security settings.

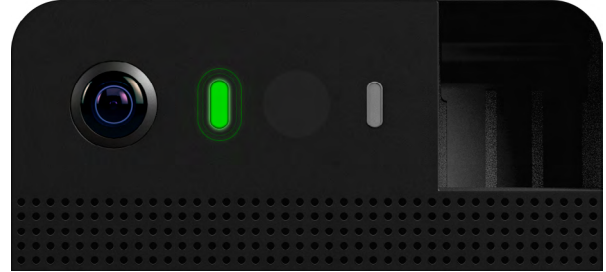

Fig. 9.8

Fast Pulsing Green

Your Petcube is downloading the most current software update, which usually takes about 5 minutes.

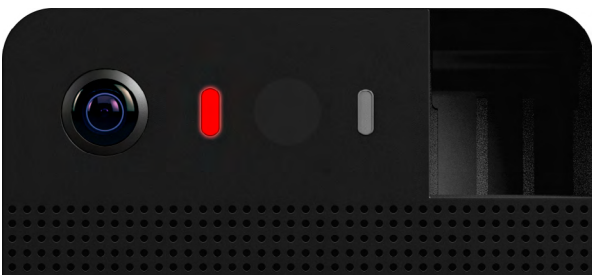

Fig. 9.9

Steady Red

Alexa mic on your Petcube is muted.